



AUTOMOTIVE AFTERMARKET SOLUTIONS



WE LISTEN. WE OBSERVE. **WE OPTIMIZE.**

INCREASE PRODUCTION

Dynabrade was founded on the tradition of giving professional tool operators and technicians tools of the highest quality, allowing their work to be completed more quickly than conventional methods. American Made Dynabrade tools and all new Dynabrade Nitro Series™ tools for collision repair and vehicle restoration in this catalog will help technicians move more vehicles through the garage in less time overall.

DECREASE LABOR

Dynabrade tools accomplish tasks more quickly or in a different fashion than traditional methods. Technicians are able to reduce time spent completing an application utilizing Dynabrade tools, which not only saves time but lowers expenses related to repair and refinishing.

INCREASE VALUE

The value Dynabrade delivers extends beyond providing high-quality, long-lasting tools and accessories. Using source capture equipment promotes a clean, safe, and healthy work environment for operators; while substantial cost savings can also be achieved by focusing on reducing cycle times for labor intensive operations.

“Using Dynabrade has been invaluable to making sure my builds look their best. From metal finishing to buffing my paint work I can fine tune my finished product. The tools are sturdy, comfortable and long lasting. There is a tool for everything we do with the quality I rely on.” ~ Miguel Perez

Miguel Perez
Extreme Paint Shop & Refinish Kulture
Palm City, FL

Refinish
Kulture



BODY SHOP

6



MULTI-PURPOSE TOOLS

24



PAINT SHOP

40



CLEAN AIR SOLUTIONS

50



ACCESSORIES

58



ABRASIVES

72



A TRADITION OF INNOVATION

Dynabrade tools have been manufactured by skilled craftsmen and women in Buffalo New York, USA for **more than 50 years**, providing operators and technicians with reliable portable air tools able to complete the most challenging applications. Teal colored tools contained within this catalog have been purposefully selected from the **over 800 industrial tool models** that Dynabrade manufactures as the best possible tool in its category for an automotive technician. These tools are intended for heavy-duty, all day, everyday use in fast-paced, high-volume work environments.

Tools for every stage in the repair or restoration of a vehicle are available from Dynabrade. Belt tools, cut-off tools, die grinders, disc sanders and other surface preparation tools typically found in the body shop are all represented in the following pages. These tools accomplish more than just preparation work, they create the foundation painters and finishers to work from before delivering the final product.

Multipurpose tools, like random orbital sanders, bridge the gap between the body shop and the paint booth and are commonly used by both body and paint technicians. Dynabrade produces the widest range of sanders and polishers in the industry so that technicians can optimize their tool choice for their specific application.

As a tool manufacturer founded on innovation, Dynabrade is excited to share for the first time a state-of-the-art polishing process hyper focused on eliminating steps in clear coat polishing applications. Dynabrade buffing tools, pads, compounds and abrasives combine to create a repeatable polishing recipe that allows technicians to quickly move more vehicles through the final repair/restoration stages.



CONTINUING THE TRADITION

Dynabrade Nitro Series™ tools are high-quality, purpose-built tools designed to provide automotive technicians with entry level, Dynabrade quality air tools. By partnering with and learning from automotive technicians Dynabrade understands that an automotive technician's daily routine can be much different than an industrial tool operator's. No two jobs are the same for a body or paint tech and job often requires a diverse selections of tools.

Like traditional Dynabrade tools, Dynabrade Nitro Series™ spans a wide variety of categories including belt tools, die grinders, disc sanders, cut-off tools as well as surface preparation tools, buffers, and polishers. Within these categories Dynabrade Nitro Series™ tools are designed to address the specific challenges automotive technicians face. A prime example is cut-off tool ECU4, featuring an extended reach for greater access to recessed areas and multi-position guard improving technician sightlines and promoting technician safety in the body shop.

Painters and finishers also benefit from Dynabrade Nitro Series™ innovations with several new buffer/polisher models now available. Model EB3 is sure to solve the challenges buffing contours and side-view mirrors present. As a compact and lightweight tool including an extension, technicians will enjoy effortless maneuverability and the ability to polish difficult to reach painted surfaces.

Dynabrade innovation in the automotive after-market is not limited to air tools. In addition to a state-of-the-art polishing system Dynabrade is also excited to introduce Extreme Orange and DynaSoft™ flexible abrasive discs. Specifically designed to be used wet or dry and available in grits up to 3000, Dynabrade now offers body and paint technicians complete solutions to their daily tasks.





BODY SHOP

Whether repairing a vehicle damaged in an accident or from weather, to restoring or customizing a classic; auto body professionals utilize a broad selection of tools in their daily tasks. Dynabrade provides technicians with dependable, ergonomic and powerful tools used for vehicle tear-down, frame & panel repair, and welding applications. The work

of the body technician must be meticulously completed, following manufacturer S.O.P.'s, and with great attention to detail because their work is the foundation for the final finish produced from the paint shop. Dynabrade tools optimize body shop applications helping technicians move vehicles quickly through a repair plan and into the paint shop.

The benefit of using Dynabrade tools extends beyond the technician to the overall bottom line of the repair facility or collision shop where significant savings can be realized. Savings can be realized through efficient abrasive use, decrease in cycle times as well as increased operator and shop safety.

VERSATILITY IN THE BODY SHOP



Using a Dynabrade Nitro Series™ NitroFile belt tool body shop technicians can quickly grind through spot welds for a fraction of the cost of using expensive spot weld cutters. Abrasive belt tools also blend welds, grind through seized bolts or even remove seam sealer making them a must-have, versatile tool for any shop.



The Dynabrade Nitro Series™ NitroZip surface preparation tool can be used with an eraser wheel to delicately remove adhesive-backed decals without excessive heat build-up, keeping painted finishes protected. When used with a wire wheel the Dynabrade Nitro Series™ NitroZip quickly removes rust and cleans around rivets.



Die Grinders provide a great deal of options for technicians within the body shop. Having a 1/4" (6 mm) collet allows for the use of burs along with coated and non-woven abrasives in a variety of shapes and sizes.

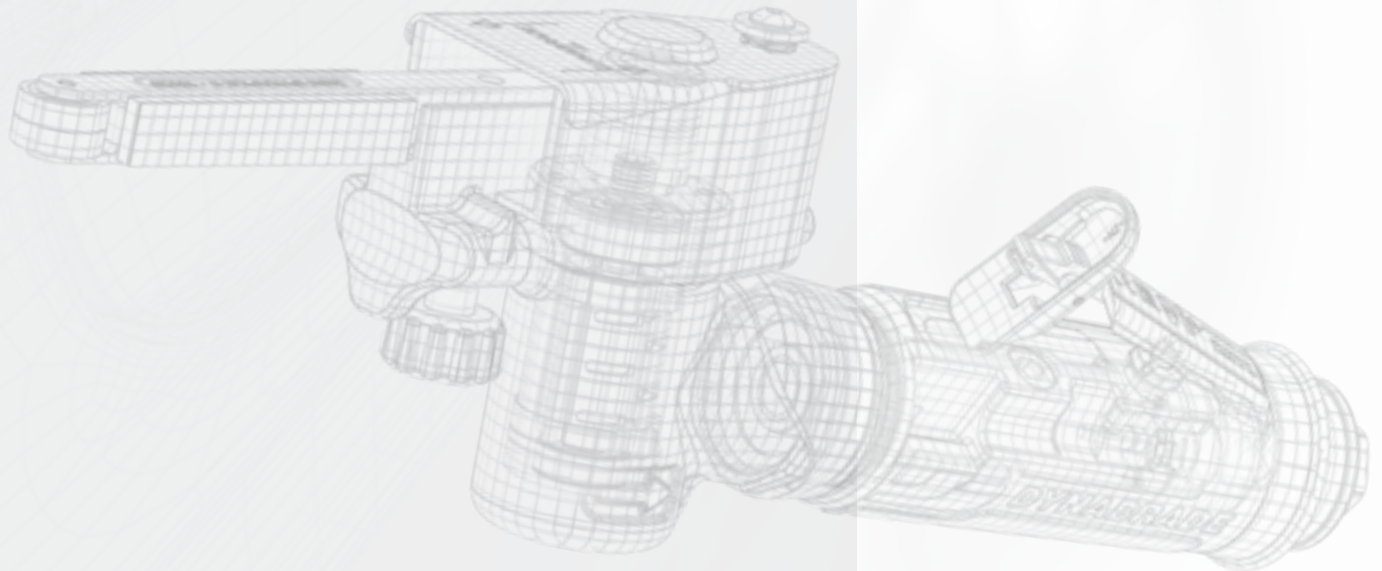

DYNABRADE NITRO SERIES™ NITROFILE ABRASIVE BELT TOOL

Abrasive belt tools can be used throughout a body shop for a variety of sanding, blending and finishing applications. Able to use both coated and non-woven abrasives allows technicians to perform a wide range of applications from spot weld and door skin removal to surface preparation when plastic welding a bumper.

FEATURES

- ▶ Sanding head pivots 360°, for working in previously inaccessible areas
- ▶ Quick and easy belt and contact arm changes
- ▶ Front exhaust directs dust away from operator and extends belt life
- ▶ Ergonomic, offset handle with safety-lock throttle lever
- ▶ Runs belts 1/4"-3/4" wide by 18" long (3 -1 9mm by 457mm)

INCLUDES

11206 Contact Arm for 1/2" wide belts

For further contact arms see page 63
For abrasives belts see as from page 88



Model NF1

GEARLESS MOTOR

SPEED
20,000 RPM

POWER
0.5 hp (373 W)

18" (457 mm) BELT

Model Number	Sound Level	Maximum Air Flow SCFM (l/min)	Air Inlet Thread	Hose Size Inch (mm)	Air Pressure PSIG (bar)	Weight Pound (kg)	Height Inch (mm)	Length Inch (mm)
NF1	81 dB(A)	22 (623)	1/4" NPT	3/8 (10)	90 (6.2)	2.8 (1.3)	5 (125)	15 (381)

DYNABRADE NITRO SERIES™ MINI-NITROFILE

A compact belt tool designed for the frequent grinding applications technicians are challenged by where space is limited and access is restricted.

FEATURES

- ▶ Sand and deburr in tight spots
- ▶ Lightweight, ergonomic and maneuverable
- ▶ Accepts coated and abrasive impregnated non-woven nylon belts
- ▶ Swing away belt guard for easy abrasive change
- ▶ Multi-position grinding head pivots 180°

INCLUDES

MNF1 includes contact arm 15026 for 1/8"-1/2" W x 12" L (3-13 mm x 305 mm) Belts
MNF13 includes contact arm 15035 for 1/8"-1/2" W x 13" L (3-13 mm x 330 mm) Belts

For further contact arms see page 63
For abrasives belts see as from page 88



Model MNF1

GEARLESS MOTOR

SPEED
25,000 RPM

POWER
0.4 hp (298 W)

12" (305 mm) BELT

Model Number	Sound Level	Maximum Air Flow SCFM (l/min)	Air Inlet Thread	Hose Size Inch (mm)	Abrasive Belt Size Inch (mm)	Air Pressure PSIG (bar)	Weight Pound (kg)	Height Inch (mm)	Length Inch (mm)
MNF1	78 dB(A)	22 (623)	1/4" NPT	1/4 (6)	1/2"x12" (13 x 305)	90 (6.2)	1.2 (0.5)	3.5 (90)	11.75 (248)
MNF13	78 dB(A)	22 (623)	1/4" NPT	1/4 (6)	1/2"x13" (13 x 330)	90 (6.2)	1.7 (0.8)	3.5 (90)	11.75 (248)

BENEFITS



Grinding hard to reach spot welds, or even through a seized or stripped bolt is easy with Dynabrade belt tools that allow technicians to access tight areas with greater control.



Using a belt rather than a drill bit is a quick, efficient and economical way to remove spot welded panels while leaving material to reattach the new or repaired panel.



The belt housing on mini-belt tools swings open for easy abrasive changes without the need for extra tools.



Being compact and lightweight makes mini-belt tools great for working in tight areas or overhead.

MINI-DYNAFILE® II

A compact belt tool designed for the frequent grinding applications technicians are challenged by where space is limited and access is restricted. The Mini-Dynafite®II is manufactured to withstand grueling applications, and be used for extended periods of time.

FEATURES

- ▶ Grind, sand, and deburr in tight spots
- ▶ Lightweight, ergonomic and maneuverable
- ▶ Accepts coated and abrasive impregnated non-woven nylon belts
- ▶ Swing away belt guard for easy abrasive change
- ▶ Multi-position grinding head pivots 180°

INCLUDES

15026 Contact Arm for 1/2" wide x 12" long abrasive belts

MINI-DYNAFILE® II VERSATILITY KIT

INCLUDES

15003 Mini-Dynafite® II
 Three Contact arms: 15026, 15028 and 15030
 Eight abrasive belts of various grits
 Sample 1/2" wide coated abrasive and non-woven nylon
 Durable carrying case



Model 15003

GEARLESS MOTOR

SPEED
25,000 RPM

POWER
0.4 hp (298 W)

12" (305 mm) BELT



Model 15006

Model Number	Sound Level	Maximum Air Flow SCFM (l/min)	Air Inlet Thread	Hose Size Inch (mm)	Air Pressure PSIG (bar)	Weight Pound (kg)	Height Inch (mm)	Length Inch (mm)
15003	80 dB(A)	20 (566)	1/4" NPT	1/4 (6)	90 (6.2)	1.8 (0.8)	3.5 (90)	11.75 (248)

RELATED PRODUCTS



Contact Arms
Page 63



Air Delivery
Accessories
Page 61



Non-Woven
Abrasive Belts
Page 94



General
Clean-up
Page 50

DYNABRADE NITRO SERIES™ 4" (100 MM) DIAMETER EXTENSION RIGHT ANGLE CUT-OFF WHEEL TOOL



Model ECU4

SPEED
14,000 RPM

POWER
1 hp (746 W)

FEATURES

- ▶ Model accepts 4" (100 mm) diameter Type 41 reinforced Cut-Off Wheels, with 3/8" center hole
- ▶ Composite grip absorbs vibration and reduces cold air transmission to operator
- ▶ Lock-lever controlled, multi-position guard
- ▶ Accepts left & right hand use due to adjustable safety guard

Model Number	Sound Level	Tool Thread	Maximum Air Flow SCFM (l/min)	Air Inlet Thread	Hose Size Inch (mm)	Air Pressure PSIG (bar)	Weight Pound (kg)	Height Inch (mm)	Length Inch (mm)
ECU4	87 dB(A)	3/8"-24	37 (1,047)	1/4" NPT	3/8 (10)	90 (6.2)	4 (1.8)	1.27 (32)	14.75 (375)

***IMPORTANT:** Speed of tool must not exceed maximum operating speed of accessory. Never mount non-reinforced grinding wheels. Always wear eye, face & body protection.

For Cutting Discs see page 91

BENEFITS



The Dynabrade Nitro Series™ ECU4 shown here provides an operator with greater control of the tool while working above head, in a difficult to reach area.

IMPORTANT: Always wear eye, face and body protection.



Cutting through panels is easy and accurate using Dynabrade cut-off tools. Powerful air motors drive abrasive wheels efficiently, and the variety of formats - straight, offset, right angle - allow operators greater control in their application.

3" (75 MM) DIAMETER 7° OFFSET CUT-OFF WHEEL TOOL

FEATURES

- ▶ Accepts 3" (75 mm) diameter reinforced Type 41 cut-off wheels with a 3/8" center hole.
- ▶ Gearless motor design for reduced maintenance and vibration.
- ▶ Front exhaust helps cool the cut-off wheel and enhances visibility while cutting.

4" (100 MM) DIAMETER EXTENSION RIGHT ANGLE CUT-OFF WHEEL TOOL

FEATURES

- ▶ Accepts 4" (100 mm) diameter reinforced Type 41 cut-off wheels with a 3/8" center hole (Wheel width of 1/32" - 1/8")
- ▶ Governor-controlled motor maintains motor rpm under heavy load
- ▶ 6" extension allows for two-hand grip, providing added control when creating long, straight cuts

3" (75 MM) DIAMETER RIGHT ANGLE CUT-OFF WHEEL TOOL

FEATURES

- ▶ Accepts 3" (75 mm) diameter reinforced Type 41 cut-off wheels with a 3/8" center hole
- ▶ Right-angle gears provide high torque, and utilize the Dynabrade "dual-wick" system for long life
- ▶ Adjustable wheel guard enhances visibility and provides maximum technician protection

Model Number	Sound Level	Maximum Air Flow SCFM (l/min)	Air Inlet Thread	Tool Thread	Weight Pound (kg)	Height Inch (mm)	Length Inch (mm)
52420	82 dB(A)	28 (793)	1/4" NPT	3/8"-24 Male	3 (1.3)	3.13 (79)	8 (202)
54736	83 dB(A)	40 (1,133)	1/4" NPT	3/8"-24 Male	3.7 (1.7)	11.37 (288)	3.1 (78)
54730	83 dB(A)	41 (1,161)	1/4" NPT	3/8"-24 Male	3.2 (1.4)	3.07 (113)	8 (202)

Additional Specifications: Air Pressure 90 PSIG (6.2 bar)

***IMPORTANT:** Speed of tool must not exceed maximum operating speed of accessory. Never mount non-reinforced grinding wheels. Always wear eye, face & body protection.



Model 52420

SPEED
20,000 RPM

POWER
0.5 hp (373 W)



Model 54736

SPEED
13,500 RPM

POWER
0.7 hp (522 W)



Model 54730

SPEED
18,000 RPM

POWER
0.7 hp (522 W)

RELATED PRODUCTS



Lubrication
Page 71



Dynaswivel®
Page 60



Abrasives
Page 72



Clean Air
Equipment
Page 50

4" (100 MM) DEPRESSED CENTER WHEEL GRINDER RIGHT ANGLE

For Fast Weld and Stock Removal, Rust and Scale Removal, Heavy Deburring

FEATURES

- ▶ Aluminum right angle head, composite housing model, rear exhaust
- ▶ "Dual-wick" lubrication system saturates gears with oil for increased performance, extended life and reduced downtime
- ▶ Accepts optional 4" (100 mm) diameter Type 27 reinforced Depressed Center Wheels, with 3/8" center hole (wheel width of 3 to 6 mm)
- ▶ Adjustable wheel guard provides maximum operator protection
- ▶ Safety-lock lever is included
- ▶ Model has side handle for left or right-hand use

Model Number	Sound Level	Maximum Air Flow SCFM (l/min)	Air Inlet Thread	Hose Size Inch (mm)	Weight Pound (kg)	Height Inch (mm)	Length Inch (mm)
54775	83 dB(A)	40 (1,133)	1/4" NPT	3/8 (10)	2.9 (1.3)	3.07 (78)	8 (202)

Additional Specifications: Air Pressure 90 PSIG (6.2 bar) • Tool Thread 3/8" -24 Male

TECH TIP Includes 95848 Gear Oil and 95541 Gear Oil Gun. Lubrication every 8 hours of run time extends gear life.

4" (100 MM) DEPRESSED CENTER WHEEL GRINDER RIGHT ANGLE

For Fast Weld and Stock Removal, Rust and Scale Removal, Heavy Deburring

FEATURES

- ▶ Steel housing models
- ▶ "Dual-wick" lubrication system saturates gears with oil for increased performance, extended life and reduced downtime
- ▶ Accepts optional 4" (100 mm) diameter Type 27 reinforced Depressed Center Wheels, with 3/8" center hole (wheel width of 3 to 6 mm)
- ▶ Adjustable wheel guard provides maximum operator protection
- ▶ Safety-lock lever is included
- ▶ Model has side handle for left or right-hand use

Model Number	Sound Level	Maximum Air Flow SCFM (l/min)	Air Inlet Thread	Hose Size Inch (mm)	Weight Pound (kg)	Height Inch (mm)	Length Inch (mm)
54773	81 dB(A)	40 (1,133)	1/4" NPT	3/8 (10)	3.5 (1.6)	11.37 (288)	3.06 (78)

Additional Specifications: Air Pressure 90 PSIG (6.2 bar) • Tool Thread 3/8" -24 Male



Model 54775

SPEED
13,500 RPM

POWER
0.7 hp (522 W)

DIAMETER
4" (100 mm)



Model 54773

SPEED
12,000 RPM

POWER
0.7 hp (522 W)

DIAMETER
4" (100 mm)

DYNABRADE NITRO SERIES™ RECIPROCATING SAW

A versatile tool used for cutting sheet metal, piping and plastic panels. Straight, accurate cuts are achievable thanks to this lightweight and easy to maneuver saw.

FEATURES

- ▶ The perfect tool for cutting materials such as plastics, fiberglass, composites, aluminum and sheet metal
- ▶ Small, lightweight design provides greater accessibility and increases operator productivity
- ▶ Adjustable rear exhaust directs air away from work piece
- ▶ Ergonomic rubber grip offers improved comfort during extended use

INCLUDES

- 90928 24 tooth saw blade
- 90929 32 tooth saw blade

Saw blades also available for purchase separately (see Page 97).



Model RS1

**9,000 STROKES
PER MINUTE**

Model Number	Strokes Per Minute	Stroke Length	Sound Level	Maximum Air Flow SCFM (l/min)	Hose Size Inch (mm)	Air Inlet Thread	Weight Pound (kg)	Height Inch (mm)	Length Inch (mm)
RS1	9,000	3/8"	83 dB(A)	9.5 (269)	3/8 (10)	1/4" NPT	1.5 (0.68)	1.75 (44)	10.4 (264)

RELATED PRODUCTS



DynaJet In-Line
Blow Gun
Safety-Tip
Design
Page 62



Dynaswivel®
Page 60



Lubricants
Page 71

Saw blades Page 97

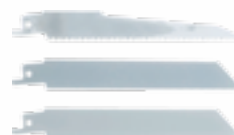

DYNABRADE NITRO SERIES™ RIGHT ANGLE DIE GRINDER

For Fast Weld and Stock Removal, Rust and Scale Removal, Heavy Deburring

FEATURES

- ▶ Compact, lightweight contemporary tool design permits easy access to tight areas
- ▶ Thermoplastic rubber tool grip reduces cold air transmission and absorbs vibration
- ▶ Smooth, efficient air motor
- ▶ Includes safety-lock lever; rotational rear exhaust to direct away from operator
- ▶ 3-piece collet, interchangeable inserts, low collet runout < .003" (0,07 mm)



Model DGR31
Model DGR32

SPEED
16,000 RPM

POWER
0.3 hp (224 W)

COLLET
1/4" or 6 mm

DYNABRADE NITRO SERIES™ RIGHT ANGLE DIE GRINDER

For Fast Weld and Stock Removal, Rust and Scale Removal, Heavy Deburring

FEATURES

- ▶ Compact, lightweight contemporary tool design permits easy access to tight areas
- ▶ Thermoplastic rubber tool grip reduces cold air transmission and absorbs vibration
- ▶ Smooth, efficient air motor
- ▶ Includes safety-lock lever; rotational rear exhaust to direct away from operator
- ▶ 3-piece collet, interchangeable inserts, low collet runout < .003" (0,07 mm)



Model DGR51
Model DGR52

SPEED
14,000 RPM

POWER
0.5 hp (373 W)

COLLET
1/4" or 6 mm

Model Number	Collet Insert	Sound Level	Maximum Air Flow SCFM (l/min)	Air Inlet Thread	Hose Size Inch (mm)	Weight Pound (kg)	Height Inch (mm)	Length Inch (mm)
DGR31	1/4"	86 dB(A)	18 (510)	1/4" NPT	3/8 (10)	1.2 (.54)	1.6 (41)	6.5 (165)
DGR32	6 mm	86 dB(A)	18 (510)	1/4" NPT	3/8 (10)	1.2 (.54)	1.6 (41)	6.5 (165)
DGR51	1/4"	84 dB(A)	26 (736)	1/4" NPT	3/8 (10)	1.6 (.73)	1.8 (46)	7.1 (180)
DGR52	6 mm	84 dB(A)	26 (736)	1/4" NPT	3/8 (10)	1.6 (.73)	1.8 (46)	7.1 (180)

Additional Specifications: Air Pressure 90 PSIG (6.2 bar)

RIGHT ANGLE DIE GRINDER

FEATURES

- ▶ Rear Exhaust Models with Standard Muffler
- ▶ Governor-controlled motor maintains speed under load
- ▶ Kevlar® phenolic vanes for longer life
- ▶ Needle bearing assures proper shaft alignment
- ▶ Lightweight ergonomic design for greater comfort and control
- ▶ Dual wick lubrication system, saturated with gear oil for extended gear life for over 700 hours



Model 48316

SPEED
15,000 RPM

POWER
0.4 hp (298 W)

COLLET
1/4" and 6 mm

RIGHT ANGLE DIE GRINDER

FEATURES

- ▶ Composite Housing Models
- ▶ All models include 1/4" and 6 mm Collet Insert
- ▶ Thermal-insulated handle reduces cold air transmission to operator
- ▶ Tools include lightweight aluminum head
- ▶ Safety-lock throttle lever prevents accidental startup of tool



Model 54343

SPEED
12,000 RPM

POWER
0.7 hp (522 W)

COLLET
1/4" and 6 mm

Model Number	Sound Level	Maximum Air Flow SCFM (l/min)	Collets Included	Air Inlet Thread	Hose Size Inch (mm)	Weight Pound (kg)	Height Inch (mm)	Length Inch (mm)
48316	79 dB(A)	25 (708)	1/4" & 6 mm	1/4" NPT	1/4 (6)	1 (.47)	2.9 (73)	6.5 (164)
54343	80 dB(A)	38 (1,076)	1/4" & 6 mm	1/4" NPT	3/8 (10)	2.2 (1)	2.88 (73)	7.8 (200)

Additional Specifications: Air Pressure 90 PSIG (6.2 bar)

RELATED PRODUCTS



DynaJet In-Line Blow Gun Safety-Tip Design Page 62



Carbide Burrs Page 98



Dynamwivel® Page 60



Filter/Regulator/Lubricator Page 60

DYNABRADE NITRO SERIES™ STRAIGHT-LINE DIE GRINDER

FEATURES

- ▶ Compact, lightweight contemporary tool design
- ▶ Thermoplastic rubber tool grip reduces cold air transmission and absorbs vibration
- ▶ Smooth, efficient air motor
- ▶ Includes safety-lock lever; rotational rear exhaust to direct away from operator
- ▶ 3-piece collet, interchangeable inserts, low collet runout < .003" (0,07 mm)



Model DGS31
Model DGS32

SPEED
25,000 RPM

POWER
0.3 hp (224 W)

COLLET
1/4" or 6 mm

DYNABRADE NITRO SERIES™ STRAIGHT-LINE DIE GRINDER

FEATURES

- ▶ Compact, lightweight contemporary tool design
- ▶ Thermoplastic rubber tool grip reduces cold air transmission and absorbs vibration
- ▶ Smooth, efficient air motor
- ▶ Includes safety-lock lever; rotational rear exhaust to direct away from operator
- ▶ 3-piece collet, interchangeable inserts, low collet runout < .003" (0,07 mm)



Model DGS51
Model DGS52

SPEED
20,000 RPM

POWER
0.5 hp (373 W)

COLLET
1/4" or 6 mm

Model Number	Collet Insert	Sound Level	Maximum Air Flow SCFM (l/min)	Air Inlet Thread	Hose Size Inch (mm)	Weight Pound (kg)	Height Inch (mm)	Length Inch (mm)
DGS31	1/4"	84 dB(A)	18 (510)	1/4" NPT	3/8 (10)	.98 (.44)	1.6 (41)	6.2 (157)
DGS32	6 mm	84 dB(A)	18 (510)	1/4" NPT	3/8 (10)	.98 (.44)	1.6 (41)	6.2 (157)
DGS51	1/4"	83 dB(A)	26 (736)	1/4" NPT	3/8 (10)	1.35 (.61)	1.8 (46)	7.4 (188)
DGS52	6 mm	83 dB(A)	26 (736)	1/4" NPT	3/8 (10)	1.35 (.61)	1.8 (46)	7.4 (188)

Additional Specifications: Air Pressure 90 PSIG (6.2 bar)

STRAIGHT-LINE DIE GRINDER

Dynabrade 0.4 hp die grinders offer an innovative design for peak efficiency and longer life. Ideal for rapid material removal, deburring, finishing and polishing.

FEATURES

- ▶ Governor-controlled motor maintains consistent motor speed under load and delivers optimal power
- ▶ Case-hardened tool cylinder to retain core toughness and prevent cracking
- ▶ Comfortable tactile grip is co-molded to composite housing, providing comfortable non-slip grip



Model 48325

SPEED
25,000 RPM

POWER
0.4 hp (298 W)

COLLET
1/4" and 6 mm

STRAIGHT-LINE DIE GRINDER

FEATURES

- ▶ Gearless for reduced maintenance
- ▶ Includes 1/4" & 6 mm collet inserts
- ▶ Front exhaust clears work area and cools abrasive



Model 51305

SPEED
18,000 RPM

POWER
0.5 hp (373 W)

COLLET
1/4" and 6 mm

Model Number	Sound Level	Maximum Air Flow SCFM (l/min)	Collets Included	Air Inlet Thread	Hose Size Inch (mm)	Weight Pound (kg)	Height Inch (mm)	Length Inch (mm)
48325	79 dB(A)	23 (651)	1/4" & 6 mm	1/4" NPT	1/4 (6)	.9 (.4)	1.7 (44)	6.5 (166)
51305	74 dB(A)	26 (736)	1/4" & 6 mm	1/4" NPT	3/8 (10)	1.8 (.8)	1.8 (48)	9.25 (235)

Additional Specifications: Air Pressure 90 PSIG (6.2 bar)



Lubrication
Page 71



Carbide Burrs
Page 98



Dynaswivel®
Page 60



Filter/Regulator/
Lubricator
Page 60

DYNABRADE NITRO SERIES™ 2" (50 MM) DIA. RIGHT ANGLE DISC SANDER

Ideal for quick weld removal, metal beveling in weld preparation, deburring and deflashing, surface conditioning and paint removal. Ergonomic tools accept locking-type abrasive discs (coated and non-woven nylon).

FEATURES

- ▶ Compact, lightweight contemporary tool design permits easy access to tight areas
- ▶ Thermoplastic rubber tool grip absorbs vibration and reduces cold air transmission
- ▶ Includes locking-type disc pad, 2" (50 mm) diameter (R-type pad)
- ▶ Smooth, efficient air motor
- ▶ Includes safety-lock lever; rear exhaust



Model DS32

SPEED
16,000 RPM

POWER
0.3 hp (224 W)

DYNABRADE NITRO SERIES™ 3" (75 MM) DIA. RIGHT ANGLE DISC SANDER

Ideal for quick weld removal, metal beveling in weld preparation, deburring and deflashing, surface conditioning and paint removal. Ergonomic tools accept locking-type abrasive discs (coated and non-woven nylon).

FEATURES

- ▶ Compact, lightweight contemporary tool design permits easy access to tight areas
- ▶ Thermoplastic rubber tool grip absorbs vibration and reduces cold air transmission
- ▶ Includes locking-type disc pad, 3" (75 mm) diameter (R-type pad)
- ▶ Smooth, efficient air motor
- ▶ Includes safety-lock lever; rear exhaust



Model DS53

SPEED
14,000 RPM

POWER
0.5 hp (373 W)

Model Number	Sound Level	Maximum Air Flow SCFM (l/min)	Tool Thread	Air Inlet Thread	Hose Size Inch (mm)	Weight Pound (kg)	Height Inch (mm)	Length Inch (mm)
DS32	86 dB(A)	18 (510)	1/4" - 20	1/4" NPT	3/8 (10)	1.2 (.54)	1.6 (41)	6.5 (165)
DS53	84 dB(A)	26 (736)	1/4" - 20	1/4" NPT	3/8 (10)	1.6 (.73)	1.8 (46)	7.1 (180)

Additional Specifications: Air Pressure 90 PSIG (6.2 bar)

2" (50 MM) NITRO WELD REMOVAL KIT

Model 22243

INCLUDES

- DS32 NITRO 2" Disc Sander
- 94300 1/4" Composite Dynaswivel
- 73593 10 DynaFire Ceramic Locking Type Sanding Disc, 50mm, P36
- 73066 10 Cotton Fibre Deburring and Finishing Locking Type Disc, P36, MED
- 22001 Apron
- Durable carrying case

3" (75 MM) NITRO WELD REMOVAL KIT

Model 22244

INCLUDES

- DS53 NITRO 3" Disc Sander
- 94300 1 - 1/4" Composite Dynaswivel
- 73597 10 DynaFire Ceramic Locking Type Sanding Disc, 75mm, P36
- 73063 10 Cotton Fibre Deburring and Finishing Locking Type Disc, P36, MED
- 22001 Aprons
- Durable carrying case



Model 22244

2" (50 MM) DIA. RIGHT ANGLE DISC SANDER

FEATURES

- ▶ Right Angle, Front Exhaust
- ▶ Wick-lube system extends gear life
- ▶ Governor-controlled motor maintains speed under load
- ▶ Includes 51344 Locking-Type Pad (2" (50 mm) diameter)

TECH TIP Motor Tune-Up Kits will extend the life of an air tool when used with a preventative maintenance schedule.



Model 47821

SPEED
15,000 RPM

POWER
0.4 hp (298 W)

3" (75 MM) DIA. RIGHT ANGLE DISC SANDER

Ideal for quick weld removal, metal beveling in weld preparation, deburring and deflashing, surface conditioning and paint removal. Ergonomic tools accept locking-type abrasive discs (coated and non-woven nylon).

FEATURES

- ▶ Composite tool housing
- ▶ Thermal-insulated handle reduces cold air transmission to operator
- ▶ Wick-lube system extends gear life
- ▶ Safety-lock throttle lever prevents accidental startup of tool



Model 54400

SPEED
18,000 RPM

POWER
0.7 hp (522 W)

Model Number	Sound Level	Maximum Air Flow SCFM (l/min)	Air Inlet Thread	Hose Size Inch (mm)	Tool Thread	Weight Pound (kg)	Height Inch (mm)	Length Inch (mm)
47821	85 dB(A)	25 (708)	1/4" NPT	1/4 (6)	1/4" - 20 Male	1.1 (.5)	3.5 (90)	4.4 (111)
54400	83 dB(A)	41 (1,161)	1/4" NPT	3/8 (10)	3/8" - 24 Male	2.3 (1)	3.5 (90)	8.5 (216)

Additional Specifications: Air Pressure 90 PSIG (6.2 bar)

RELATED PRODUCTS



Lubrication
Page 71



Dynamswivel®
Page 60



Abrasives Discs
DS 323
Page 93

DYNABRADE NITRO SERIES™ NITROZIP SURFACE PREPARATION TOOL

Using a Dynabrade Nitro Series™ NitroZip equipped with a wire wheel allows technicians to remove rust and seam sealers in preparation for repair or replacement of damaged vehicle components. Sharp wire wheels cut quickly, and do not "load" with thick, gummy sealer. Wheels can be resharpened by reversing the direction of the wire rotation and running on a hard surface.

FEATURES

- ▶ Dynabrade Nitro Series™ NitroZip tool outperforms conventional spiral-wound wheels without clogging
- ▶ Excellent power for effectively removing seam sealer and paint
- ▶ Tool duplicates sand-blasting effect without surface fatigue
- ▶ Excellent for removing two-sided adhesive molding tape and decal material with use of rubber eraser wheel
- ▶ Eraser Wheel has serrations for improved cooling effect air flow. Also resists heat buildup and reduces jumping and vibration



Model NZ1

SPEED
3,500 RPM

POWER
0.5 hp (373 W)

Tool included wheel hub only
Eraser and Wire Wheels sold separately

Model Number	Sound Level	Maximum Air Flow SCFM (l/min)	Air Inlet Thread	Hose Size Inch (mm)	Weight Pound (kg)	Height Inch (mm)	Length Inch (mm)
NZ1	83 dB(A)	28 (792)	1/4" NPT	3/8 (10)	2.6 (1.2)	3.25 (83)	10.7 (272)
NZ1K	83 dB(A)	28 (792)	1/4" NPT	3/8 (10)	2.6 (1.2)	3.25 (83)	10.7 (272)

Additional Specifications: Air Pressure 90 PSIG (6.2 bar)

TECH TIP

When using the Dynabrade Nitro Series™ NitroZip with a wire or eraser wheel apply gentle pressure to the work surface keeping the tool in motion for easy surface preparation and decal removal.

BENEFITS



When equipped with a wire wheel the Dynabrade Nitro Series™ NitroZip removes seam sealer quickly and without clogging leaving the surface below ready for rework.



Using an eraser wheel the Dynabrade Nitro Series™ NitroZip quickly removes decals without harming the paint below, as well as removing adhesives without smearing on the painted surface.

DYNABRADE NITRO SERIES™ NITROZIP KIT NZ1K

INCLUDES

- NZ1 Standard Tool
- 92252 1/2" Wheel Hub Assembly (1)
- 92248 1/2" Coarse Wire Wheel (1)
- 92239 3/4" Wheel Hub Assembly (1)
- 92245 3/4" Coarse Wire Wheel (1)
- 92255 RED-TRED® Zip Eraser Wheel (1)



Model NZ1K

SPEED
3,500 RPM

POWER
0.5 hp (373 W)

RELATED PRODUCTS



Coarse Wire
Wheels
Page 63



Beige
Eraser Wheel
Page 63



Hub
Page 63



Lubrication
Page 71



MULTI-PURPOSE TOOLS

Random orbital, orbital, and in-line sanders are used throughout the stages of vehicle repair and restoration from prep work in the body shop to finish work before buffing in the paint shop. The wide range of Dynabrade sanders offered for applications throughout the shop allow technicians to always have the right sander for the job. Cutting through layers of clear, paint and primer or leveling body filler can be performed faster and with

fewer abrasives when the tool and abrasive are matched to the size and severity of the application. Optimizing these applications can call for an aggressive 3/8" (10 mm) orbit palm sander or even a "Mudhog" (gear-driven sander) with a coarse grit abrasive to move vehicles more quickly to the paint booth.

Tools like the DynaLocke® provide technicians with a single tool capable of performing like a disc sander and a dual

action in multiple different tasks by switching between rotary and random orbital sanding action. Jitterbug, or power block, sanders are ideal when sanding corners or leveling large surface like a hood or roof top. Versatility within the shop is a critical component to optimizing a process for fast and repeatable results, and having the right tool or tools for the job can make all the difference.

DYNORBITAL® VERSATILITY



Feather Edging

When sanding to bare metal Dynabrade random orbital sanders can be operated at full throttle to remove surface defects as well as prepare deep dents. The random orbital can then be throttled back for feather-edging applications, providing technicians with greater control and helping prevent the removal of too much material in preparation for new paint.



Clear Coat Repair

Using a sequence of grits, the Dynorbital® Extreme quickly levels worn clear coat, a critical step to matching or re-establishing the finish or a repaired portion of a vehicle to the factory finish. Without a level surface prior to buffing or polishing the final finish can appear dull or faded rather than a high-gloss polish.



Headlight Repair

In addition to paint prep and clear coat repair Dynabrade random orbital sanders are often used to restore the clarity of headlight covers. After leveling the scratches and dings created by gravel and other debris impacting headlight covers, a palm-style buffer is used to apply the final finish.

DYNORBITAL-SPIRIT® RANDOM ORBITAL SANDER

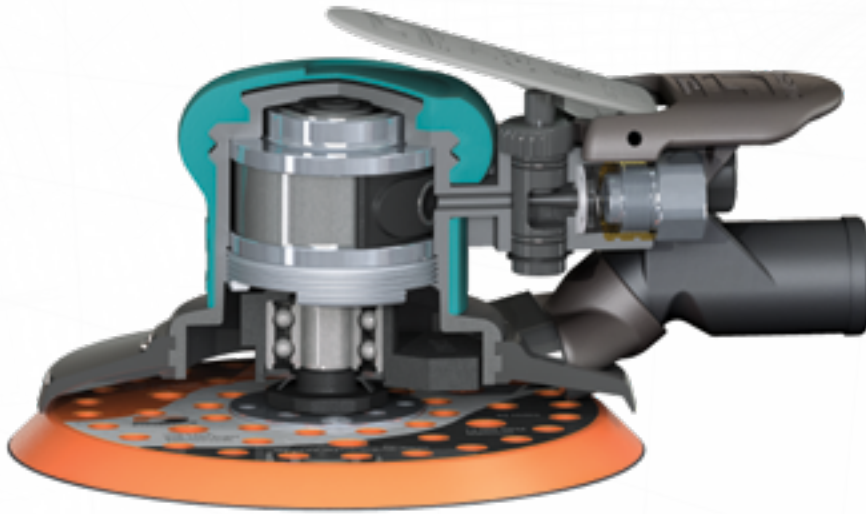

COMPACT GRIP

Ergonomically designed to fit naturally in operator hands

RECESSED THROTTLE LEVER

Eliminates pressure point on operator's hand

COMFORT PLATFORM

Provides hand and wrist support

SPEED CONTROL

Adjust speed for sensitive substrates

WEIGHT-MATED PAD

Minimizes vibration

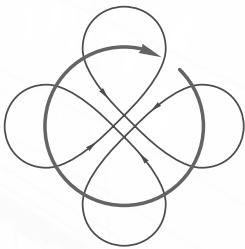

**3/8" (10 mm)
DIAMETER ORBIT**
Aggressive Sanding
Orange Throttle Lever

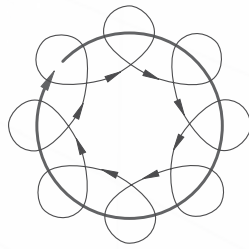

**3/16" (5 mm)
DIAMETER ORBIT**
General Sanding
Gray Throttle Lever

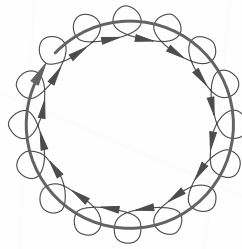

**3/32" (2.5 mm)
DIAMETER ORBIT**
Ultra-Fine Sanding
Black Throttle Lever

BENEFITS



The Dynorbital-Spirit® is the lightest random orbital sander from Dynabrade and is ideal for vertical feather-edging applications where technicians are working in front of their body or at eye level with a vehicle raised on a lift. Weighing less than 1 kg the Spirit sander reduces operator fatigue and relieves stress on wrists and arms. Improve shop air quality by combining with Dynabrade Mini-Raptor Vacs®.

MATERIAL REMOVAL APPLICATIONS

Dynorbital-Spirit® sanders with a 3/8" (10 mm) orbit make quick work of heavy material removal applications. The wide throw sands a greater surface area than general and fine finishing sanders.



**3/8" (10 mm)
DIAMETER ORBIT**
Aggressive Sanding
Orange Throttle Lever

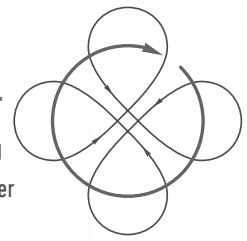

NON-VACUUM

Model Number	Diameter Inch (mm)	Pad Style	Sound Level	Weight Pound (kg)	Length Inch (mm)
59100	3 (75)	Hook-face	81 dBA	1.6 (.7)	7 (180)
59005	5 (125)	Hook-face	81 dBA	1.5 (.7)	6.5 (165)
59010	6 (150)	Hook-face	82 dBA	1.6 (.7)	7 (180)

SELF-GENERATED VACUUM

Model Number	Diameter Inch (mm)	Pad Style	Sound Level	Weight Pound (kg)	Length Inch (mm)
59103	3 (75)	Hook-face	84 dBA	1.5 (.7)	8.5 (216)
59008	5 (125)	Hook-face	82 dBA	1.6 (.7)	8.5 (216)
59013	6 (150)	Hook-face	85 dBA	1.7 (.7)	9 (230)

CENTRAL VACUUM

Model Number	Diameter Inch (mm)	Pad Style	Sound Level	Weight Pound (kg)	Length Inch (mm)
59104	3 (75)	Hook-face	79 dBA	1.5 (.7)	7 (180)
59009	5 (125)	Hook-face	83 dBA	1.5 (.7)	7.25 (184)
59014	6 (150)	Hook-face	84 dBA	1.6 (.7)	7.75 (197)

Additional Specifications:

Pad Thread 5/16"-24 Male • Air Inlet Thread 1/4" NPT • Hose I.D. Size 1/4" (6 mm)
Air Flow Rate 14 SCFM (396 L/PM) • Height 3-1/2" (90 mm) • Air Pressure 90 PSIG (6.2 bar)
Sound Level is the pressure measurement according to the method outlined in ISO regulation ISO-15744



SPEED
12,000 RPM

POWER
0.25hp (186 W)

DIAMETER
75 mm, 125 mm
& 150 mm

TECH TIP

For a swirl-free finish, always start the sander on the work surface and stop the sander off the surface.

RELATED PRODUCTS



Backing Pads
Page 64



Coated Abrasives
Discs
Page 78



Swivel Adaptor
Page 62



Raptor Vac®
Vacuum
Systems
Page 52

GENERAL SANDING

Dynorbital-Spirit® sanders with a 3/16" (5 mm) orbit are an excellent choice for general purpose sanding, able to remove material and feather-edge surfaces when combined with a wide range of abrasive grits.



**3/16" (5 mm)
DIAMETER ORBIT**
General Sanding
Gray Throttle Lever

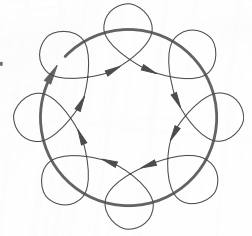

NON-VACUUM

Model Number	Diameter Inch (mm)	Pad Style	Sound Level	Weight Pound (kg)	Length Inch (mm)
59105	3 (75)	Hook-face	79 dBA	1.4 (.6)	6.5 (165)
59020	5 (125)	Hook-face	80 dBA	1.4 (.6)	6.5 (165)
59025	6 (150)	Hook-face	81 dBA	1.5 (.7)	7 (180)

SELF-GENERATED VACUUM

Model Number	Diameter Inch (mm)	Pad Style	Sound Level	Weight Pound (kg)	Length Inch (mm)
59108	3 (75)	Hook-face	83 dBA	1.4 (.6)	8.5 (216)
59023	5 (125)	Hook-face	82 dBA	1.5 (.7)	8.5 (216)
59028	6 (150)	Hook-face	85 dBA	1.6 (.7)	9 (230)

CENTRAL VACUUM

Model Number	Diameter Inch (mm)	Pad Style	Sound Level	Weight Pound (kg)	Length Inch (mm)
59109	3 (75)	Hook-face	83 dBA	1.4 (.6)	7.25 (184)
59024	5 (125)	Hook-face	81 dBA	1.5 (.6)	7.25 (184)
59029	6 (150)	Hook-face	83 dBA	1.6 (.7)	7.75 (197)



SPEED
12,000 RPM

POWER
0.25hp (186 W)

DIAMETER
75 mm, 125 mm
& 150 mm

Additional Specifications:

Pad Thread 5/16"-24 Male • Air Inlet Thread 1/4" NPT • Hose I.D. Size 1/4" (6 mm)
Air Flow Rate 14 SCFM (396 L/PM) • Height 3-1/2" (90 mm) • Air Pressure 90 PSIG (6.2 bar)
Sound Level is the pressure measurement according to the method outlined in ISO regulation ISO-15744



See Page 64

DynaMaze® Vacuum Pad

- ▶ Exclusive mesh design accepts all abrasive types and hole configurations.
- ▶ Efficient, hook-face technology.
- ▶ Increased vacuum capability promotes operator safety.
- ▶ Reduced vibration for operator comfort.
- ▶ Unique single-piece hub design ensures tool balance and further reduces vibration.

ULTRA-FINE SANDING

Dynorbital-Spirit® sanders with a 3/32" (2.5 mm) orbit are best utilized in fine finishing and surface repair applications. Delicate enough to level clear coats in preparation for buffing and final finishing.



**3/32" (2.5 mm)
DIAMETER ORBIT**
Ultra-Fine Sanding
Black Throttle Lever

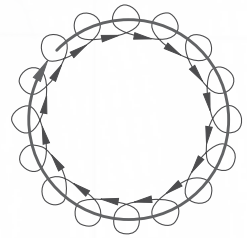

NON-VACUUM

Model Number	Diameter Inch (mm)	Pad Style	Sound Level	Weight Pound (kg)	Length Inch (mm)
59110	3 (75)	Hook-face	81 dBA	1.3 (.6)	7 (180)
59035	5 (125)	Hook-face	81 dBA	1.4 (.6)	6.5 (165)
59040	6 (150)	Hook-face	82 dBA	1.6 (.7)	7 (180)

SELF-GENERATED VACUUM

Model Number	Diameter Inch (mm)	Pad Style	Sound Level	Weight Pound (kg)	Length Inch (mm)
59113	3 (75)	Hook-face	85 dBA	1.4 (.6)	9 (230)
59038	5 (125)	Hook-face	81 dBA	1.5 (.7)	8.5 (216)
59043	6 (150)	Hook-face	86 dBA	1.5 (.7)	9 (230)

CENTRAL VACUUM

Model Number	Diameter Inch (mm)	Pad Style	Sound Level	Weight Pound (kg)	Length Inch (mm)
59114	3 (75)	Hook-face	84 dBA	1.4 (.6)	7.75 (197)
59039	5 (125)	Hook-face	83 dBA	1.4 (.6)	7.75 (184)
59044	6 (150)	Hook-face	80 dBA	1.5 (.7)	7.75 (197)

Additional Specifications:

Pad Thread 5/16"-24 Male • Air Inlet Thread 1/4" NPT • Hose I.D. Size 1/4" (6 mm)
Air Flow Rate 14 SCFM (396 L/PM) • Height 3-1/2" (90 mm) • Air Pressure 90 PSIG (6.2 bar)
Sound Level is the pressure measurement according to the method outlined in ISO regulation ISO-15744



SPEED
12,000 RPM

POWER
0.25hp (186 W)

DIAMETER
75 mm, 125 mm
& 150 mm



RELATED PRODUCTS



Backing Pads
Page 64



Coated Abrasives
Discs
Page 78



Coupler and
Plug Assembly
Page 61



Raptor Vac®
Vacuum
Systems
Page 52

DYNORBITAL® EXTREME RANDOM ORBITAL SANDER SERIES

Dynabrade proudly introduces our most refined random orbital sander to date. The Dynorbital® Extreme boasts the greatest power and most consistent speed of any palm-style orbital sander. Power and speed combine to quickly and reliably produce the desired finish, while ergonomic features keep operators safe and comfortable throughout their day. Symmetrical design allows left or right-handed operators to work comfortably, while the compact size of the Dynorbital® Extreme fits naturally in most operator's hands.

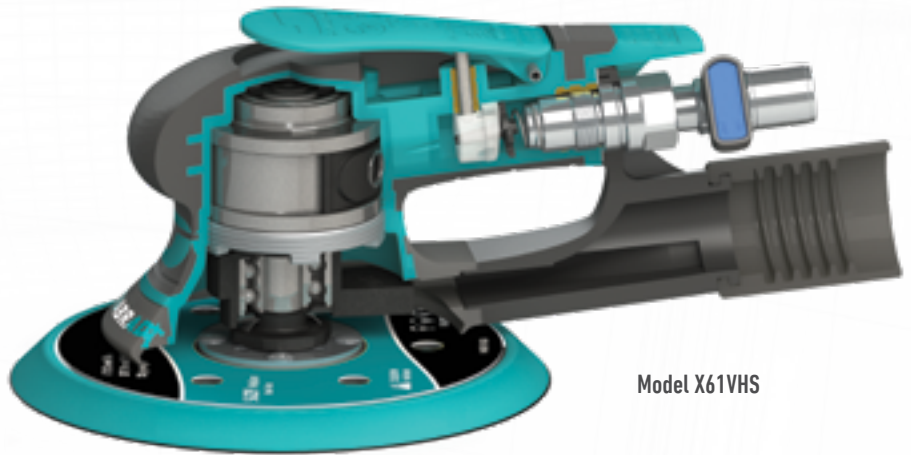

Model X61VHS

FEATURES

- ▶ Recessed throttle lever
- ▶ Integrated comfort platform
- ▶ Comfort grip
- ▶ Lip Seal Shroud
- ▶ Weight-Mated Backing Pad
- ▶ Integrated Swivel Cuff
- ▶ Increased Port Size

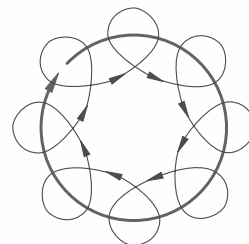

**3/16" (5 mm)
DIAMETER ORBIT**
General Sanding
Teal Throttle Lever

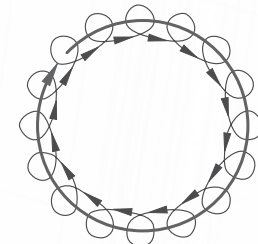

**3/32" (2.5 mm)
DIAMETER ORBIT**
Ultra-Fine Sanding
Black Throttle Lever

**TECH
TIP**

For a swirl-free finish, always start the sander on the work surface and stop the sander off the surface.

ESD MODELS

Model Number	Diameter Inch (mm)	Orbit Dia. Inch (mm)	RPM	Ground Wire	Includes ESD Hose Ass	Vacuum	Vacuum Hose Connection	Power	Air Consumption
X51ESD	5 (125)	3/16 (5)	12,000	Yes	...	Central Vacuum	1° Threaded	0.3 hp (224 W)	19 SCFM (538 LPM)
X52ESD	5 (125)	3/32 (2.5)							
X61ESD	6 (150)	3/16 (5)	12,000	Yes	...	Central Vacuum	1° Threaded	0.3 hp (224 W)	19 SCFM (538 LPM)
X62ESD	6 (150)	3/32 (2.5)							

Additional Specifications:

Additional Specifications Vacuum Port - 1" | Air Inlet - 1/4" NPT | Hose I.D. - 1/4" (6 mm) | ROS Pads have a 5/16"-24 Male Thread

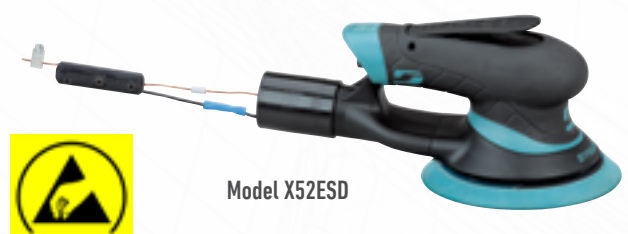

Model X52ESD

NON-VACUUM

Model Number	Diameter Inch (mm)	Pad Type	Orbit Dia. Inch (mm)	Sound Level	Weight Pound (kg)	Length Inch (mm)
X31*	3 (75)	Hook-face	3/16 (5)	75 dBA	1.19 (0.54)	5.9 (151)
X32*	3 (75)	Hook-Face	3/32 (2.5)	74 dBA	1.23 (0.56)	7.1 (182)
X51	5 (125)	PSA	3/16 (5)	74 dBA	1.78 (0.8)	6.9 (176)
X51H	5 (125)	Hook-Face	3/16 (5)	73 dBA	1.78 (0.8)	6.9 (176)
X52	5 (125)	PSA	3/32 (2.5)	73 dBA	1.74 (0.8)	6.9 (176)
X52H	5 (125)	Hook-Face	3/32 (2.5)	72 dBA	1.74 (0.8)	6.9 (176)
X61	6 (150)	PSA	3/16 (5)	72 dBA	1.86 (0.8)	7.4 (188)
X61H	6 (150)	Hook-Face	3/16 (5)	78 dBA	1.86 (0.8)	7.4 (188)
X62	6 (150)	PSA	3/32 (2.5)	73 dBA	1.82 (0.8)	7.4 (188)
X62H	6 (150)	Hook-Face	3/32 (2.5)	75 dBA	1.82 (0.8)	7.4 (188)

CENTRAL VACUUM

Model Number	Diameter Inch (mm)	Pad Type	Orbit Dia. Inch (mm)	Sound Level	Weight kg (Pound)	Length mm (Inch)
X31V*	3 (75)	Hook-Face	3/16 (5)	81 dBA	1.17 (0.53)	5.9 (150)
X32V*	3 (75)	Hook-Face	3/32 (2.5)	83 dBA	1.23 (0.56)	7.1 (181)
X51V	5 (125)	Hook-Face	3/16 (5)	74 dBA	1.94 (0.9)	9.1 (230)
X52V	5 (125)	Hook-Face	3/32 (2.5)	74 dBA	1.9 (0.9)	9.1 (230)
X61V	6 (150)	Hook-Face	3/16 (5)	73 dBA	2.02 (0.9)	9.5 (242)
X62V	6 (150)	Hook-Face	3/32 (2.5)	73 dBA	1.98 (0.9)	9.5 (242)

SPEED CONTROL SERIES - FOR VARIABLE SPEED

Model Number	Diameter Inch (mm)	Pad Type	Orbit Dia. Inch (mm)	Sound Level	Weight Pound (kg)	Length Inch (mm)
X51VHS	5 (125)	Hook-Face	3/16 (5)	74 dBA	2.04 (0.94)	9.1 (230)
X51HS	5 (125)	Hook-Face	3/16 (5)	73 dBA	1.88 (0.85)	6.5 (165)
X61VHS	6 (150)	Hook-Face	3/16 (5)	73 dBA	2.12 (0.96)	9.5 (242)
X61HS	6 (150)	Hook-Face	3/16 (5)	75 dBA	1.96 (0.89)	7.4 (188)

Additional Specifications:

Height: 3.7" (95 mm) • Air Inlet: 1/4" NPT • Air Hose I.D.: 1/4" (6 mm) • Air Pressure: 90 PSIG (6.2 bar)
Maximum Air Flow: 19 SCFM (538 L/PM)

RELATED PRODUCTS



Backing Pads
Page 64



Coated Abrasives
Discs
Page 78



Speed Control
Page 60



M Class
Vacuum
System
Page 54



SPEED

12,000 RPM

POWER

0.1 hp for 3" (75 mm) Models
0.3 hp for 5" (125 mm) & 6"
(150 mm) Models



* All 3" models are equipped with an integrated speed regulator.

TECH TIP

Adding flow control airline connector 95756 allows technicians to "dial in" the speed of the Dynorbital® Extreme for each application.



Model X61VHS

2-HAND RANDOM ORBITAL SANDER

With nearly twice the power of a traditional palm-style random orbital sander two-hand sanders efficiently power larger diameter discs and abrasives. The added handle and throttle lever provide technician with greater control especially when working on vertical sides of a vehicle.

FEATURES

- ▶ 5" (125 mm) and 6" (150 mm) models are 12,000 RPM. Pads have 5/16"-24 male thread
- ▶ 8" (200 mm) models are 10,000 RPM. Pads mount with 5 screws
- ▶ Central Vacuum models include combination lip seal/overskirt shroud, which offers enhanced vacuum capability

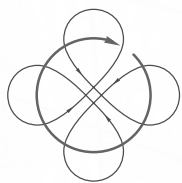

**3/8" (10 mm)
DIAMETER ORBIT**
Aggressive Sanding

Model Number	Vacuum Type	Diameter Inch (mm)	Sound Level	Weight Pound (kg)	Length Inch (mm)	Height Inch (mm)
58415	Non-Vacuum	5 (125)	82 dBA	2.5 (1.1)	11 (280)	4.94 (126)
58419	Non-Vacuum	6 (150)	84 dBA	2.5 (1.1)	11.37 (288)	4.94 (126)
58420	Central Vacuum	5 (125)	81 dBA	2.7 (1.2)	11.37 (288)	4.94 (126)

Additional Specifications: Air Inlet Thread 1/4" NPT • Hose I.D. Size 1/4" • Air Pressure 90 PSIG (6.2 bar)

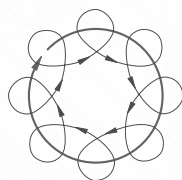

**3/16" (5 mm)
DIAMETER ORBIT**
General Sanding

Model Number	Vacuum Type	Diameter Inch (mm)	Sound Level	Weight Pound (kg)	Length Inch (mm)	Height Inch (mm)
58400	Non-Vacuum	5 (125)	82 dBA	2.5 (1.2)	11 (280)	4.93 (126)
58405	Non-Vacuum	6 (150)	81 dBA	2.6 (1.2)	11.37 (288)	4.93 (126)
58410	Non-Vacuum	8 (200)	82 dBA	4.0 (1.8)	12.5 (319)	5.62 (142)
58409	Central Vacuum	6 (150)	84 dBA	2.7 (1.2)	11.37 (288)	4.93 (126)
58414	Central Vacuum	8 (200)	85 dBA	4.2 (1.9)	12.5 (319)	5.62 (142)

Additional Specifications: Air Inlet Thread 1/4" NPT • Hose I.D. Size 1/4" • Air Pressure 90 PSIG (6.2 bar)
Maximum Air Flow 23 SCFM / 651 L/Min

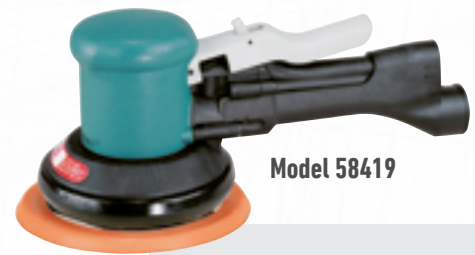

Model 58419

SPEED
12,000 RPM

POWER
0.45 hp (336 W)

DIAMETER
5" (125 mm), 6" (150 mm)



Model 58414

SPEED
8" Models 10,000 RPM
5", 6" Models 12,000 RPM

POWER
0.45 hp (336 W)

DIAMETER
5" (125 mm), 6" (150 mm),
8" (200 mm)

GEAR-DRIVEN SANDER

Gear-Driven Sanders or "Mudhog" sanders are utilized for quick, aggressive removal and leveling of body filler, glues and coatings. These slow-speed, high-torque sanders have an epicycloidal motion that typically combines with coarse grit abrasives to optimize preparation stages allowing operators to spend less time sanding.

FEATURES

- ▶ Ergonomically designed for low vibration and reduced sound levels
- ▶ Speed control lever is conveniently located for easy thumb adjustment
- ▶ Insulated tool housing reduces cold air transmission to the hand

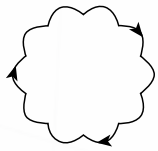

EPICYCLOIDAL MOTION

Aggressive Sanding

Model Number	Diameter Inch (mm)	Vacuum Type	Weight Pound (kg)	Height Inch (mm)	Length Inch (mm)
58442	6 (150)	Non-Vacuum	3.6 (1.7)	5.62 (143)	11.5 (293)
58443	6 (150)	Central	3.8 (1.7)	5.62 (143)	11.5 (293)
58445	8 (200)	Non-Vacuum	3.9 (1.8)	5.56 (142)	12.5 (293)
58446	8 (200)	Central	4.3 (2.0)	5.56 (142)	12.5 (319)

Additional Specifications: Air Inlet Thread 1/4" NPT • Hose I.D. Size 1/4" • Air Pressure 90 PSIG (6.2 bar)
Maximum Air Flow 23 SCFM / 651 (L/Min)



Model 58442

SPEED

900 RPM

POWER

0.45 hp (336 W)

DIAMETER

6" (150 mm), 8" (200 mm)



Model 58443

RELATED PRODUCTS



Backing Pads
Page 64



A/O Film
and Paper
Discs
Page 74



Optional
Vacuum Hose
Assembly
Page 68



M Class
Vacuum
System
Page 54

DYNALOCKE®

The DynaLocke® is truly “two tools in one,” easily changing from a rotary Disc Sander to Random Orbital Sander with a turn of the dial. Repair technicians can increase their productivity by accomplishing paint stripping and feather edging applications with one tool.

FEATURES

- ▶ Switch is recessed within tool grip for comfort and to prevent accidental engaging
- ▶ Speed control lever is conveniently located for easy thumb adjustment
- ▶ Insulated tool housing reduces cold air transmission to the hand

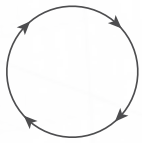

ROTARY MOTION

Stripping and Blending

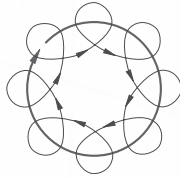

**3/16" (5 mm)
DIAMETER ORBIT**
General Sanding



Model 58436

SPEED

12,000 RPM

POWER

0.45 hp (336 W)

DIAMETER

3" (75 mm), 5" (125 mm),
6" (150 mm)

Model Number	Diameter Inch (mm)	Sound Level	Maximum Air Flow SCFM (L/min)	Weight Pound (kg)	Height Inch (mm)	Length Inch (mm)	Vacuum
58460	3 (75)	81 dB(A)	23 (651)	2.35 (1.0)	5.37 (137)	10.31 (263)	Non-Vacuum
58461	3 (75)	86 dB(A)	23 (651)	2.35 (1.0)	5.37 (137)	10.31 (263)	Self-Generated Vacuum
58430	5 (125)	82 dB(A)	23 (651)	2.7 (1.2)	5.12 (131)	11 (280)	Non-Vacuum
58435	6 (150)	82 dB(A)	23 (651)	2.8 (1.2)	5.12 (131)	11 (280)	Non-Vacuum
58436	6 (150)	85 dB(A)	23 (651)	2.7 (1.2)	5.12 (131)	11 (280)	Self-Generated Vacuum

Additional Specifications: Air Inlet Thread 1/4" NPT • Hose I.D. Size 1/4" • Air Pressure 90 PSIG (6.2 bar) Maximum Air Flow 23 SCFM (651 L/Min) • Tool Thread 5/16" - 24 Female



Tool should be completely stopped before changing sanding action.

BENEFITS



The DynaLocke® quickly strips paint to bare metal when set to rotary mode and converts to random orbital to complete the feather-edging portion of the application.

DYNABUG® “MODEL T” SANDER

"Model T" sanders are incredibly lightweight, fine-finishing sanders that require very little air flow to reach peak performance, making them ideal for shops without large compressors. Square or circular pads available in several sizes combine with 3/32" orbit provide technicians with a versatile finishing orbital sander.

FEATURES

- ▶ Lightweight... less than 500 grams! Palm-style, ergonomic design features low profile grip for greater operator comfort and control
- ▶ Operates 9 SCFM (254 l/min) & 90 PSIG (6.2 bar). Can be run by as little as 3 horsepower compressor

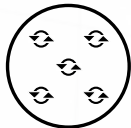
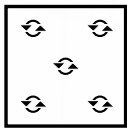

ORBITAL MOTION

Featheredge, Finish,
Sand and Blend

Model Number	Pad Size Inch	Pad Diameter Inch (mm)	Sound Level	Weight Pound (kg)	Length Inch (mm)	Height Inch (mm)	Vacuum
57920	4 x 4.31	—	68 dB(A)	1 (.5)	5 (125)	3 (75)	Non-Vacuum
57922	—	5 (125)	68 dB(A)	1 (.5)	5.5 (140)	3 (75)	Non-Vacuum
57923	4.25 x 4.5	—	68 dB(A)	1 (.5)	5.5 (140)	3 (75)	Non-Vacuum
57924	—	5 (125)	68 dB(A)	1 (.5)	5.5 (140)	3 (75)	Non-Vacuum
57926	—	6 (150)	68 dB(A)	1 (.5)	5 (125)	3 (75)	Non-Vacuum
57927	—	6 (150)	68 dB(A)	1 (.5)	5 (125)	3 (75)	Non-Vacuum
57929	4.25 x 4.5	—	73 dB(A)	1 (.5)	5 (125)	3 (75)	Central Vacuum

Additional Specifications: Air Inlet Thread 1/4" NPT • Hose I.D. Size 1/4" • Air Pressure 90 PSIG (6.2 bar)
Maximum Air Flow 9 SCFM / 255 L/Min

WET DYNABUG® “MODEL T” SANDER

Model Number	Pad Diameter Inch (mm)	Sound Level	Weight Pound (kg)	Length Inch (mm)	Height Inch (mm)
57908	5 (125)	76 dBA	1.5 (0.7)	8 (200)	4 (100)
57909	5 (125)	76 dBA	1.5 (0.7)	8 (200)	4 (100)

Additional Specifications: Air Inlet Thread 1/4" NPT • Hose I.D. Size 1/4" • Air Pressure 90 PSIG (6.2 bar)
Maximum Air Flow 17 SCFM / 481 L/Min



Model 57920

SPEED
20,000 RPM

TURBINE-STYLE

Turbine-style, vaneless air motor needs no oil making "Model T" perfect for areas where sensitive finishes are being produced.

TECH TIP

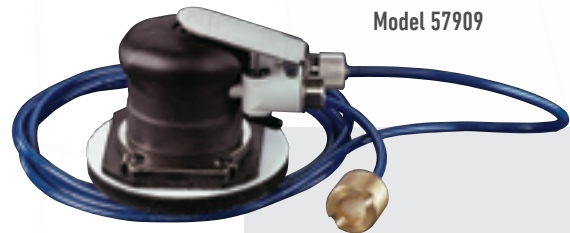

Model 57909

SPEED
20,000 RPM

TURBINE-STYLE

RELATED PRODUCTS



Coupler and Plug Assembly
Page 61



General Clean-up
Page 50

DYNABUG® II SANDER

Compact and lightweight, Dynabug® II Orbital Sanders access tight areas while limiting operator fatigue – especially when sanding on vertical surfaces. Dynabug® II tools are ideal for feathering applications where creating surfaces with excellent mechanical adhesion qualities is critical in preparation for painting and final finish.

FEATURES

- Designed to be light weight, ergonomic with a comfort platform to provide additional hand and wrist support



ORBITAL MOTION

General Sanding

Model Number	Pad Size Inch (mm)	Pad Type	Vacuum Type	Orbit	Sound Level	Weight Pound (kg)	Length Inch (mm)
58500	3 x 4-1/4 (75 x 108)	Hook-face	Non-Vacuum	3/32" (2.5 mm)	78 dBA	1.7 (.78)	6.8 (171)
58503	3-1/4 x 5 (82 x 127)	Hook-face	Non-Vacuum	3/32" (2.5 mm)	78 dBA	1.7 (.78)	7.2 (182)
58507	2-2/3 x 6 7/8 (68 x 175)	Hook-face	Non-Vacuum	3/32" (2.5 mm)	82 dBA	2.2 (.98)	8 (280)
58510	3 x 4 (75 x 100)	Hook-face	Non-Vacuum	3/32" (2.5 mm)	84 dBA	1.7 (.78)	6.5 (171)
58511	2-2/3 x 6 7/8 (68 x 175)	Hook-face	Non-Vacuum	3/32" (2.5 mm)	84 dBA	1.8 (.82)	8 (200)
58516	2-2/3 x 7-3/4 (68 x 196)	Hook-face	Non-Vacuum	3/32" (2.5 mm)	83 dBA	1.8 (.82)	8.5 (215)
58502	3 x 4-1/4 (75 x 108)	Hook-face	Central	3/32" (2.5 mm)	83 dBA	1.8 (.82)	7 (180)
58505	3-1/4 x 5 (82 x 127)	Hook-face	Central	3/32" (2.5 mm)	81 dBA	1.8 (.82)	7.5 (190)
58512	2-2/3 x 7-3/4 (68 x 196)	Hook-face	Central	3/32" (2.5 mm)	84 dBA	1.9 (.86)	8.75 (222)
58513	2-2/3 x 6-7/8 (68 x 175)	Hook-face	Non-Vacuum	3/16" (5 mm)	81 dBA	1.9 (.86)	8.1 (206)
58514	2-2/3 x 7-3/4 (68 x 196)	Hook-face	Non-Vacuum	3/16" (5 mm)	81 dBA	1.9 (.86)	8.6 (218)
58515	2-2/3 x 7-3/4 (68 x 196)	Hook-face	Central	3/16" (5 mm)	80 dBA	2.0 (.91)	8.9 (226)

Additional Specifications: Air Inlet Thread 1/4" NPT • Hose I.D. Size 1/4" (6 mm) • Air Pressure 90 PSIG (6.2 bar) Maximum Air Flow 13 SCFM (368 L/Min) • Height 3.7" (94 mm)



Model 58512

SPEED

3/16" (5 mm) Models
8,000 RPM

3/32" (2.5 mm) Models
10,000 RPM

POWER

0.15 hp (112 W)



Model 58502

BENEFITS



Dynabug® sanders are an ideal choice for use in feather edging applications. The rectangular pad and delicate orbital motion allow technicians to sand in corners without undercutting. When equipped with a long-nap pad and non-woven nylon abrasives Dynabug® and Dynabug®II sanders are excellent scuffing and blending tools.

DYNABUG® SANDER

Dynabug® orbital sanders are available in two separate orbit patterns - 3/16" (5 mm) or 3/32" (2.5 mm) - and are recommended for general sanding of horizontal surfaces or for fine sanding and feathering. Being slightly larger and heavier than the Dynabug® II relieves operators of having to apply heavy downward force when leveling a surface in preparation for paint and finishing.

FEATURES

- Dynabug® sanders can be equipped with a long-nap pad (57852) used with non-woven nylon abrasives for scuffing applications



ORBITAL MOTION
For General Sanding

Model Number	Vacuum Type	Orbit	Speed RPM	Sound Level	Weight Pound (kg)	Length Inch (mm)
57800	Non-Vacuum	3/16" (5 mm)	8,000	82 dBA	2.5 (1.2)	11 (280)
57804	Central	3/16" (5 mm)	8,000	81 dBA	2.5 (1.2)	11.37 (288)
57810	Non-Vacuum	3/32" (2.5 mm)	10,000	84 dBA	2.5 (1.2)	11 (280)
57814	Central	3/32" (2.5 mm)	10,000	84 dBA	2.5 (1.2)	11.37 (280)

Additional Specifications: Air Inlet Thread 1/4" NPT • Hose I.D. Size 1/4" • Air Pressure 90 PSIG (6.2 bar) Height 4.93" 126 mm • Maximum Air Flow 16 SCFM / 453 L/Min

LONG BOARD AND HALF SHEET SANDERS

Two-hand control for blocking applications and for use in vertical applications.

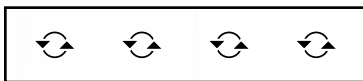

ORBITAL MOTION
For General Sanding

Model Number	Pad Size (mm)	Orbit	Sound Level	Weight (kg)
58550	70 x 400	5 mm	80 dBA	2.5
58551	100 x 400	5 mm	85 dBA	2.6
58552	225 x 115	5 mm	78 dBA	2.4

Additional Specifications: Air Inlet Thread 1/4" NPT • Hose I.D. Size 1/4" • Air Pressure 90 PSIG (6.2 bar) Maximum Air Flow 23 SCFM / 651 L/Min

RELATED PRODUCTS



Backing Pads
Page 66



Vacuum Hose
Assembly
Page 68



General
Clean-up
Page 50



Maximum
90 PSIG (6.2 bar)



Model 57800

SPEED
8,000 RPM

POWER
0.24 hp (179 W)



Model 57814

SPEED
10,000 RPM

POWER
0.28 hp (209 W)

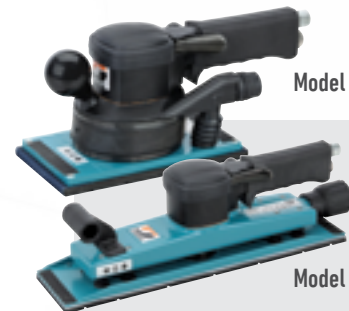

Model 58552

Model 58551

SPEED
10,000 RPM

POWER
0.5 hp (373 W)

DYNALINE SANDER

In-Line Sanders are ideal for leveling filler or blocking using adhesive backed coated and non-woven abrasives. Use long nap, hook-face pad number 57471 with model 57400 with non-woven abrasives for scuffing and blending.

FEATURES

- ▶ Uses adhesive-backed coated and non-woven nylon sheets and rolls
- ▶ Quality constructed pad is weight-mated to tool for low vibration, smooth operation and superior finishes
- ▶ Comfort platform provides additional hand and wrist support
- ▶ 2,400 strokes per minute at 90 PSIG (6.2 Bar)



IN-LINE MOTION

For Stripping and Blending

Model Number	Vacuum Type	Size	Sound Level	Weight Pound (kg)	Length Inch (mm)	Height Inch (mm)
57400	Non-Vacuum	2-3/4" x 8" (70 x 200 mm)	79 dBA	2.6 (1.2)	7 (180)	3.75 (95)
57404	Central Vacuum	2-3/4" x 8" (70 x 200 mm)	84 dBA	2.6 (1.2)	7 (180)	3.75 (95)
51350	Non-Vacuum	2-3/4" x 11" (70 x 280 mm)	81 dBA	3.1 (1.4)	11 (280)	3.75 (95)

Additional Specifications: Air Inlet Thread 1/4" NPT • Hose I.D. Size 1/4" (6 mm) • Air Pressure 90 PSIG (6.2 bar) Maximum Air Flow 18 SCFM (510 L/Min)

See Page 66 for Backing Pad options



Model 57400

SPEED
2,400 RPM

POWER
0.3 hp (223 W)



Model 51350

TECH TIP Backing Pad can be rotated 360° for adjusting to most efficient position per application.



BENEFITS



The in-line sanding motion of a Dynaline sander provides technicians with a powered option for completing traditional hand blocking applications. When used with non-woven abrasives Dynaline sanders are a great option for scuffing and surface preparation applications.

“After 60 plus years in the auto repair world, the oldest saying still rings true! 'Time is Money'. In early times most tasks were done by hand. The right power tool did not exist! For Professional Grade Tooling and Equipment you can't do better than Dynabrade. Engineered to perform and last!” ~Jon Kosmoski, still at it since 1956

*Jon Kosmoski
Kosmoski Specialty Company
Minneapolis, MN*





PAINT SHOP

Dynabrade tools and accessories in the paint shop are manufactured to create consistent, high-gloss finishes in the fewest steps possible. Buffers and polishers in a wide variety of sizes and formats provide

technicians with options to finish large areas like hoods and trunk lids as well as small and hard to reach areas like headlights, side view mirrors, and even navigate around motorcycle frames to polish fuel tanks. Air and electric

powered buffing and polishing tools utilizing wool, foam, or terry cloth bonnets are available to technicians so that each application can be optimized for the desired cut rate leading to an optimal finish.

SUPERIOR FINISHES IN THE PAINT SHOP



Dynabrade offers small diameter buffers for use on headlights and small areas where other buffers cannot reach or maneuver around. Pictured here is a Sander/Buffer combination tool that allows technicians to toggle between rotary and random orbital motions with the flip of a switch. Providing versatile tools that can accomplish multiple tasks is one way Dynabrade helps maximize productivity.



When establishing a final finish, it is important to apply compound to the surface of the pad and then blot additional compound on the area to be polished. Because of the self-diminishing abrasive technology in Dynabrade compounds it is critical to have fresh compound throughout the area to be polished, adhering to this step will ensure even and consistent results.



The Dynabrade finishing system consisting of buffers, pads and compounds can be seen here achieving a high-gloss, showroom finish on a dark painted front quarter panel. The buffer is easily controlled having two grip points, while the buffing pad conforms to the contours of the vehicle creating a consistent finish.

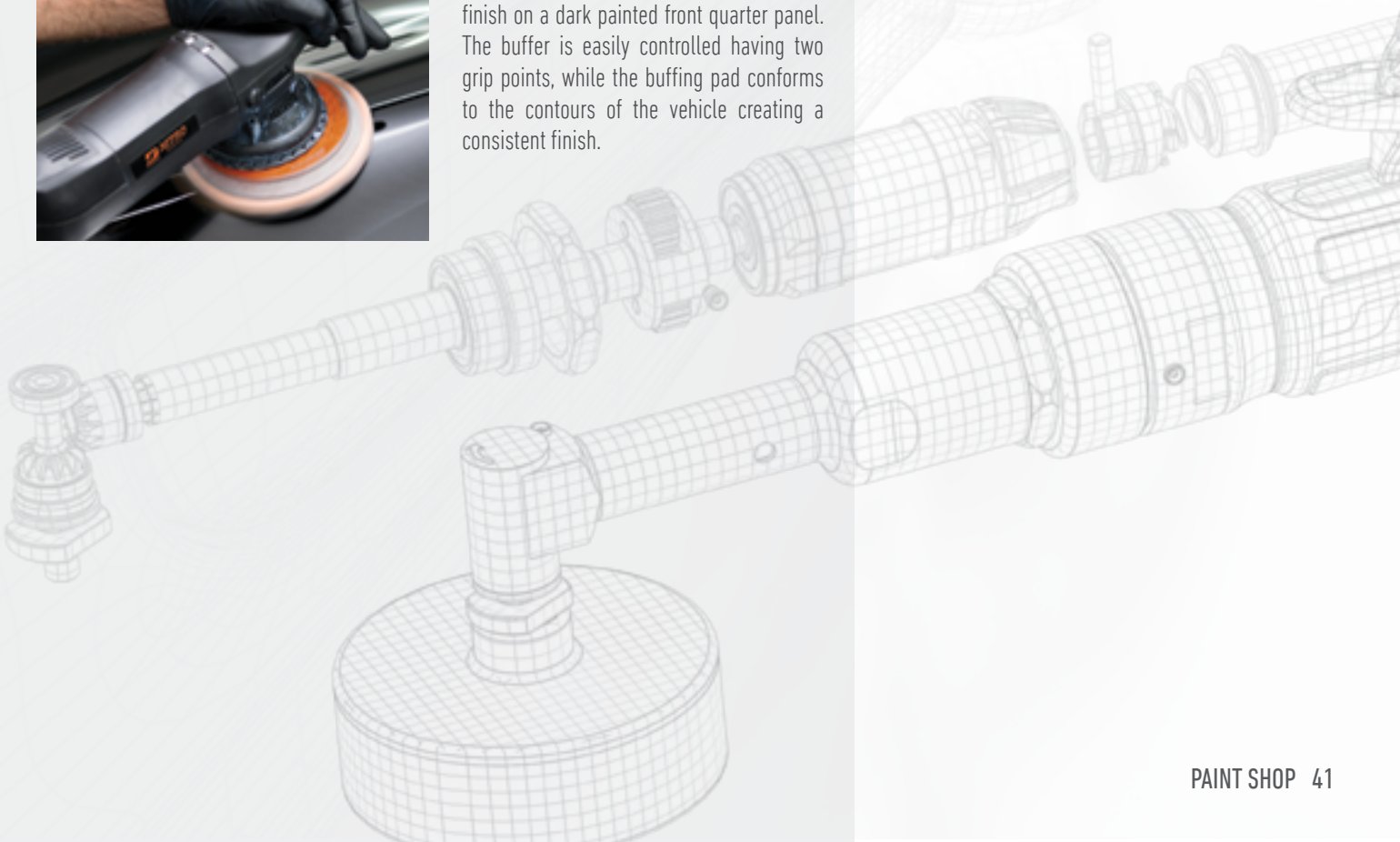

PALM-STYLE ROTARY BUFFERS

Ideal for buffing door/window columns and posts, plus recessed areas and contoured surfaces. Best for repair of sanding scratches in clear coat.

FEATURES

- ▶ Low profile housing
- ▶ Adjustable speed regulator

INCLUDES

- 50125 rigid 3" backing pad
- 90027 Terry Cloth Pad
- 90028 Wool Pad

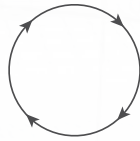

ROTARY MOTION

For Rotary Polishing



Model 57550

DIAMETER
3" (75 mm)

SPEED
2,400 RPM

POWER
0.25 hp (186 W)

TECH TIP

Use Dynabrade DynaRed® and DynaOrange® to achieve a superior high gloss finish after compounding.

PALM-STYLE MINI-DYNORBITAL®

- ▶ Ideal for repairing dust nibs and minor surface defects
- ▶ Convenient, non-marring hanger bracket for easy tool storage
- ▶ Includes 1-1/4" dia. locking-type Backing Pad (54037)

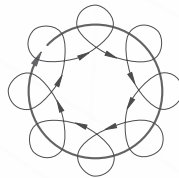

3/16" (5 mm) DIAMETER ORBIT

For Sanding and Polishing



Model 69502

DIAMETER
1-1/4" (32 mm)

SPEED
7,500 RPM

POWER
0.08 hp (60 W)

Model Number	Sound Level	Maximum Air Flow SCFM (l/min)	Hose I.D. Size Inch (mm)	Tool Thread	Weight Pound (kg)	Height Inch (mm)	Length Inch (mm)
57550	79 dB(A)	18 (510)	1/4 (6)	1/4"-20 Male	1.9 (.9)	4.25 (108)	5.37 (137)
69502	75 dB(A)	6 (170)	1/4 (6)	Locking	1.3 (.6)	3.31 (84)	6 (150)

Additional Specifications: Air Inlet Thread 1/4" NPT • Hose I.D. Size 1/4" • Air Pressure 90 PSIG (6.2 bar)

3" (75 MM) DIAMETER SANDER/BUFFER

FEATURES

- ▶ Dual-purpose tool offers random orbital sanding and rotary buffing
- ▶ Repairs dust nibs and blemishes in paints and clear coats
- ▶ Also used to repair hazy/cloudy headlights, and other clear/colored acrylic surfaces
- ▶ 3" (76 mm) diameter allows use on contoured surfaces and tight areas
- ▶ In rotary mode, offers all the benefits of model 69550

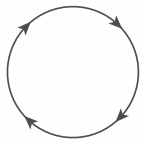

ROTARY MOTION

For Rotary Polishing

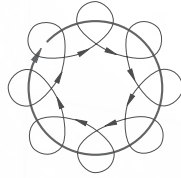

3/16" (5 mm) DIAMETER ORBIT

For Sanding and Polishing



Model 69540

DIAMETER
3" (75 mm)

SPEED
12,000 RPM

POWER
0.2 hp (149 W)

Model Number	Sound Level Sanding	Sound Level Buffing	Maximum Air Flow SCFM (l/min)	Air Inlet Thread	Hose I.D. Size Inch (mm)	Air Pressure PSIG (bar)	Weight Pound (kg)	Height Inch (mm)	Length Inch (mm)
69540	71 dB(A)	74 dB(A)	12 (334)	1/4" NPT	1/4 (6)	90 (6.2)	1.5 (.67)	3.7 (94)	6.1 (154)

RELATED PRODUCTS



Polishing Pads & Foams
Page 103



Polishing Compounds
Page 100

DYNABRADE NITRO SERIES™ 3" (75 MM) EXTENDED BUFFER

Compact and lightweight the Dynabrade Nitro Series™ extended buffer is perfect for use in tight areas or contoured painted surfaces like side-view mirrors.

FEATURES

- ▶ Tool includes 50126 Hook-Face Backup Pad
- ▶ Tactile, thermoplastic grip
- ▶ 3/8"-24 male spindle, rear exhaust
- ▶ Rotational rear exhaust directs cold air away from operator

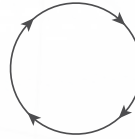

ROTARY MOTION
For Rotary Buffing



Model EB3

DIAMETER
3" (75 mm)

SPEED
2,700 RPM

POWER
0.5 hp (373 W)

Model Number	Sound Level	Spindle Thread	Maximum Air Flow SCFM (l/min)	Hose I.D. Size Inch (mm)	Weight Pound (kg)	Height Inch (mm)	Length Inch (mm)
EB3	81 dB(A)	3/8" - 24 male	26 (736)	3/8 (10)	1.6 (.72)	3 (75)	11.25 (286)

Additional Specifications: Air Inlet Thread 1/4" NPT • Air Pressure 90 PSIG (6.2 bar)

DYNABRADE NITRO SERIES™ 5" (125 MM) – 8" (200 MM) BUFFER

Dynabrade Nitro Series™ buffers polish large areas like hoods and trunk lids quickly and with consistent results.

FEATURES

- ▶ 2,800 RPM free speed. Accepts 5" to 8" diameter buffs
- ▶ Lightweight and compact in size
- ▶ Rear exhaust, variable speed safety-lock lever throttle
- ▶ Soft-grip handle can be positioned for right or left hand operation
- ▶ Insulated handle reduces cold air transmission to the operator

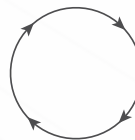

ROTARY MOTION
For Rotary Buffing



Model RB1

DIAMETER
5" - 8" (125 mm - 200 mm)

SPEED
2,800 RPM

POWER
1 hp (746 W)

* Backing Pad (50853) and polishing bonnet (90082) not included

Model Number	Pad Size Inch (mm)	Sound Level	Spindle Thread	Maximum Air Flow SCFM (l/min)	Hose I.D. Size Inch (mm)	Weight Pound (kg)	Height Inch (mm)	Length Inch (mm)
RB1	8 (200)	89 dB(A)	5/8" - 11 Male	48 (1359)	3/8 (10)	4.8 (122)	12.5 (318)	2.5 (64)
RB2	8 (200)	89 dB(A)	M14	48 (1359)	3/8 (10)	4.8 (122)	12.5 (318)	2.5 (64)

Additional Specifications: Air Inlet Thread 3/8" NPT • Hose I.D. Size 3/8" • Air Pressure 90 PSIG (6.2 bar)

3" (75 MM) DIAMETER BUFFER

Compact and lightweight with a specially engineered ergonomic, co-molded housing that fits naturally in and insulates a technicians hands from cold air transfer.

FEATURES

- ▶ Tool comes mounted with 54021 Adapter (1/4"-20 male thread)
- ▶ Governor-controlled motor maintains speed under load
- ▶ Extended rear exhaust muffler, safety-lock lever, rotary action

INCLUDES

- 50120 3" diameter Hook-Face Pad
- 90027 Terry Cloth Bonnet
- 90028 Wool Buffering Bonnet

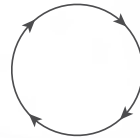

ROTARY MOTION
For Rotary Buffering



Model 49440

DIAMETER
3" (75 mm)

SPEED
3,200 RPM

POWER
0.4 hp (298 W)

Model Number	Sound Level	Tool Thread	Maximum Air Flow SCFM (l/min)	Hose Size Inch (mm)	Weight Pound (kg)	Height Inch (mm)	Length Inch (mm)
49440	79 dB(A)	1/4" - 28 Female	26 (736)	1/4 (6)	1.9 (.9)	2.6 (67)	13 (331)

Additional Specifications: Air Inlet Thread 1/4" NPT • Air Pressure 90 PSIG (6.2 bar)

6" (150 MM) - 8" (200 MM) DIAMETER BUFFER

Dynabrade buffers that utilize planetary gear sets have been specifically designed for demanding, high-torque applications covering large areas like on commercial trucks, busses and delivery vehicles.

FEATURES

- ▶ Planetary gear set is easily lubricated for extended tool life
- ▶ Safety-lock throttle and soft-grip handle both adjust for left or right hand use

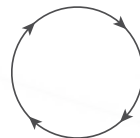

ROTARY MOTION
For Rotary Buffering



Model 51396

DIAMETER
6" - 8" (150 mm - 200 mm)

SPEED
2,800 RPM

POWER
1 hp (744 W)

Model Number	Sound Level	Tool Thread	Maximum Air Flow SCFM (l/min)	Hose I.D. Size Inch (mm)	Weight Pound (kg)	Height Inch (mm)	Length Inch (mm)
51392	78 dB(A)	5/8" - 11 Male	41 (1,167)	3/8 (10)	4.5 (2.1)	3.75 (95)	13.25 (333)
51396	78 dB(A)	M14 x 2 Male	41 (1,167)	3/8 (10)	4.5 (2.1)	3.75 (95)	13.25 (333)

Additional Specifications: Air Inlet Thread 3/8" NPT • Air Pressure 90 PSIG (6.2 bar)

RELATED PRODUCTS



Polishing Pads & Foams
Page 103



Polishing Compounds
Page 100

DYNABRADE NITRO SERIES™ ELECTRIC ROTARY POLISHERS AND RANDOM ORBITAL BUFFER

Model 51592



ELECTRIC ROTARY POLISHER

DIAMETER
6" - 8" (150 mm - 200 mm)

SPEED
Variable up to 2,100 RPM

POWER
1450W

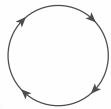

ROTARY MOTION

FEATURES

- ▶ Premium high torque "Nitro" Rotary Polisher for heavy duty polishing applications
- ▶ Includes 6" (150 mm) Backing Pad 57543 (on request replaced by 5" (125 mm) backing pad 57542)
- ▶ 7 meters flexible and oil resistant electric cord for maximum maneuverability
- ▶ Variable 7 step speed dial easily adjusts the speed up to 2,100 RPM while in use
- ▶ Includes nose cover and side handle 42705
- ▶ M14 spindle thread and spindle lock button
- ▶ Soft start trigger with Lock-On button
- ▶ Thermal overload protection to prevent overheating
- ▶ External accessible carbon brushes

Model RB4



ELECTRIC ROTARY POLISHER

DIAMETER
5" - 6" (125 mm - 150 mm)

SPEED
Variable up to 3,300 RPM

POWER
1000W

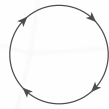

ROTARY MOTION

FEATURES

- ▶ High quality "Nitro" Rotary Polisher for all-round polishing applications
- ▶ Includes 5" (125 mm) Backing Pad 57542
- ▶ 7 meters flexible and oil resistant electric cord for maximum maneuverability
- ▶ Variable 6 step speed dial easily adjusts the speed up to 3,300 RPM while in use
- ▶ Easily removes scratches and small paint defects
- ▶ Auto shut-off carbon brushes
- ▶ M14 spindle thread and spindle lock button
- ▶ Soft start trigger with Lock-On button
- ▶ Slight & ergonomic design with low noise and vibration values
- ▶ Fast, efficient and easy to use
- ▶ Comes with canvas sports bag for dust-free storage

Model ROB2



ELECTRIC RANDOM ORBITAL BUFFER

DIAMETER
5" - 6" (125 mm - 150 mm)

SPEED
Variable up to 5,000 RPM

POWER
1000W

ORBIT
21 mm



RANDOM ORBITAL MOTION

FEATURES

- ▶ High quality "Nitro" Random Orbital Buffer for excellent buffing applications
- ▶ Includes 5" & 6" (125 & 150 mm) backing pad resp. 56180 & 54327 and 17 mm wrench 95263
- ▶ 7 meters flexible and oil resistant electric cord for maximum maneuverability
- ▶ Variable 6 step speed dial easily adjusts the speed up to 5,000 RPM while in use
- ▶ 21 mm orbit achieves excellent hologram-free finishes on paints and clear coats
- ▶ Keeps the painted surfaces cool and produces showroom gloss
- ▶ Auto shut-off carbon brushes
- ▶ On/Off safety switch
- ▶ Fast, efficient and easy to use

Model Number	Supports Pad Diameter	Maximum Watts Out	Thread	Voltage EU Plug	Frequency	Weight kg (lbs)	Height mm (inch)	Length mm (inch)
51592	150 mm & 200 mm	1450	M14 x 2 Male	220-240 V	50-60 Hz	2.6 (5.7)	197 (7.75)	394 (15.5)
RB4	125 mm & 150 mm	1000				2.1 (4.6)	85 (3.34)	485 (19.09)
ROB2	125 mm & 150 mm	1000	5/16"-24 Female			2.7 (5.9)	100 (3.93)	470 (18.5)

3" (75 MM) DIA. DYNABUFFER RANDOM ORBITAL POLISHER

FEATURES

- ▶ Dynabuffer moves backup pad and optional polishing buff in 14 mm diameter offset orbit. Tool runs at 10,000 RPM free speed, then slows to 7,000 RPM under load.
- ▶ Non-marring housing cover is insulated for operator comfort. Optional 53163 Side Handle available.
- ▶ Throttle lever may be positioned for right or left hand operation.



Model 57126

5" (125 MM) DIA. DYNABUFFER RANDOM ORBITAL POLISHER

FEATURES

- ▶ Dynabuffer moves optional backup pad and optional polishing buff in 14 mm diameter offset orbit.
- ▶ Non-marring housing cover is insulated for operator comfort.
- ▶ Front Exhaust for better cooling of surface and Backing Pad which results in longer lifetime of Backing Pad
- ▶ Tool includes Safety-Lock Throttle Lever.



Model 58456

Model Number	Motor hp	Motor RPM	Sound level	Maximum Air Flow SCFM (l/min)	Hose I.D. Size mm (Inch)	Air Pressure PSIG (bar)	Tool Thread	Weight kg (Pound)	Length mm (Inch)	Height mm (Inch)
57126	0,16	10.000	74 dB(A)	20 (566)	10 (3/8)	90 (6.2)	5/16"-24 Female	0.9 (2.0)	210 (8-1/4)	80 (3-1/8)
58456	0,3	10.000	82 dB(A)	16 (453)	8 (1/4)	90 (6.2)	5/16"-24 Female	1.2 (2.7)	277 (11)	125 (4-15/18)

RIGHT ANGLE MINI-ORBITAL SANDER 32 MM (1-1/4") DIA. RIGHT ANGLE MINI-ORBITAL SANDER

FEATURES

- ▶ Designed for removing dust nibs and surface defects on paints and clear coats.
- ▶ Finesse sanding of small areas. Precise 1/8" orbital action minimizes swirl marks.
- ▶ Lightweight design for operator comfort.
- ▶ Includes 1-1/4" Vinyl Face Med, Rubber Disc Pad (54018)
- ▶ Tool includes 95745 1/4" Flow Control, 95848 Gear Oil and 95541 Push-Type Gun, for lubricating tool gears through dual-wick system.



Model 58037A

Model Number	Motor hp	Motor RPM	Sound level	Maximum Air Flow SCFM (l/min)	Hose I.D. Size mm (Inch)	Orbit mm (Inch)	Air Inlet Throat	Weight kg (Pound)	Length mm (Inch)	Height mm (Inch)
58037A	0,4	12.000	85 dB(A)	20 (566)	6 (1/4")	3 (1/8)	1/4" NPT	0.7 (1.6)	137 (5.4)	97 (3.8)

2-STEP KIT 3" (75 MM) DYNABUFFER WITH DYNARED

Model 22820

INCLUDES

- 57126 3" (75 mm) Dia. Dynabuffer Random Orbital Polisher
 - 58037A 1/4" (32 mm) Diam. Mini Orbital Sander
 - 74000 2 Black Conical Polishing Foam 87mm 1 Hole
 - 74001 2 Blue Conical Polishing Foam 87mm 1 Hole
 - 22770 Dynabrade PSA Denibbing Discs P3000 (100 pcs/tube)
 - 22017 1L DynaRed Polish Compound
 - 22050 4 Microfibre Wipes Orange
 - 22001 Apron
- Durable carrying case



2-STEP KIT 5" (125 MM) DYNABUFFER WITH DYNARED

Model 22821

INCLUDES

- 58456 5" (125 mm) Dia. Dynabuffer Random Orbital Polisher
 - 58037A 1-1/4" (32 mm) Diam. Mini Orbital Sander
 - 74009 2 Black Conical Polishing Foam 138mm 1 Hole
 - 74010 2 Blue Conical Polishing Foam 138mm 1 Hole
 - 22770 Dynabrade PSA Denibbing Discs P3000 (100 pcs/tube)
 - 22017 1L DynaRed Polish Compound
 - 22050 4 Microfibre Wipes Orange
 - 22001 Apron
- Durable carrying case



DENIBBING AND POLISHING KIT

Model 22822

INCLUDES

- 69502 Mini-Dynorbital Silver 7500rpm
- 58455 5" (125 mm) Dia. Dynabuffer Random Orbital Polisher
- 73502 Microfiber Polishing Pad 135mm
- 74012 Grey Conical Polishing Foam 138mm 1 Hole
- 74010 Black Conical Polishing Foam 138mm 1 Hole
- 22770 Dynabrade PSA Denibbing Disc P3000 (100 pcs/tube)
- 22017 1L DynaRed Polish Compound
- 22021 1L DynaOrange Polish Compound
- 22050 2 Microfibre Wipes Orange
- 22045 Spray Bottle
- 22048 Spray Trigger
- Durable carrying case



22822

NITRO ELECTRIC POLISHING KIT

Model 22824

INCLUDES

- 22707 Sport Bag
- 51592 8" (200 mm) Dia. Electric Right Angle Polisher
- 57543 6" Hook Face Pad with M14x2 spindle
- 22021 1L DynaOrange Polish Compound
- 22017 1L DynaRed Polish Compound
- 74016 2 Grey Conical Polishing Foam 160mm 1Hole
- 74014 2 Blue Conical Polishing Foam 160mm 1Hole
- 22050 2 Microfibre Wipes Orange



22824

2-STEP KIT 5" (125 MM) DYNABUFFER WITH DYNATEAL

Model 22826

INCLUDES

- 58456 5" (125 mm) Dia. Dynabuffer Random Orbital Polisher
- 58037A 1-1/4" (32 mm) Diam. Mini Orbital Sander
- 74009 2 Black Conical Polishing Foam 138mm 1 Hole
- 74010 2 Blue Conical Polishing Foam 138mm 1 Hole
- 22770 Dynabrade PSA Denibbing Discs P3000 (100 pcs/tube)
- 22011 1L DynaTeal Polish Compound
- 22050 4 Microfibre Wipes Orange
- 22001 Apron
- Durable carrying case



22826

PREMIUM POLISHING KIT

Model 22823

INCLUDES

- 58456 5" (125 mm) Dia. Dynabuffer Random Orbital Polisher
- 73502 Microfiber Polishing Pad 135mm
- 74012 Grey Conical Polishing Foam 138mm 1 Hole
- 74010 Black Conical Polishing Foam 138mm 1 Hole
- 53965 Interface Pad 150mm 15 holes
- 24676 Clog Free Sanding Disc 150mm Diam. 15 holes P2000 (25pcs)
- 22017 1L DynaRed Polish Compound
- 22021 1L DynaOrange Polish Compound
- 22050 2 Microfibre Wipes Orange
- 22045 Spray Bottle
- 22048 Spray Trigger
- Durable carrying case



22823

2-STEP KIT 3" (75 MM) DYNABUFFER WITH DYNATEAL

Model 22825

INCLUDES

- 57126 3" (75 mm) Dia. Dynabuffer Random Orbital Polisher
- 58037A 1-1/4" (32 mm) Diam. Mini Orbital Sander
- 74000 2 Black Conical Polishing Foam 87mm 1 Hole
- 74001 2 Blue Conical Polishing Foam 87mm 1 Hole
- 22770 Dynabrade PSA Denibbing Discs P3000 (100 pcs/tube)
- 22011 1L DynaTeal Polish Compound
- 22050 4 Microfibre Wipes Orange
- 22001 Apron
- Durable carrying case



22825

3" (75 MM) NITRO EXTENDED BUFFER POLISHING KIT WITH DYNARED

Model 22245

INCLUDES

- EB3 NITRO 3" Extension Buffer / Polisher
- 22017 1L DynaRed Polish Compound
- 56150 2 Microfiber polishing pads 80mm
- 74002 2 Grey Conical Polishing Foam 87mm 1Hole
- 74001 2 Blue Conical Polishing Foam 87mm 1Hole
- 22050 2 Microfibre Wipes Orange
- Durable carrying case



22845



CLEAN AIR SOLUTIONS

Dynabrade Raptor Vac® sanding systems tackle a variety of applications from everyday shop cleanup to demanding sanding applications and even metallic dust collection. The combination of HEPA filtration and certified M-Class, Division 1 and Division 2 vacuums contribute to an optimal work environment by assuring the efficient capture

of dusts like body filler, or aluminum dusts respectively. The power cord and vacuum hose combine with the mobility of a cart or casters to provide up to 12 meters of reach for operators; giving them flexibility to move throughout the shop.

Dynabrade clean air solutions are highly customizable and exceptionally easy to

maintain. Additional hoses and connectors allow for the expansion of a vacuum from a one-person unit to a system for two operators working simultaneously. Unlike many other vacuum systems the filters and bags in Dynabrade Raptor Vacs® are easily accessible and allow for easy maintenance throughout the life of the system.

VACUUMS FOR HEALTH AND SAFETY

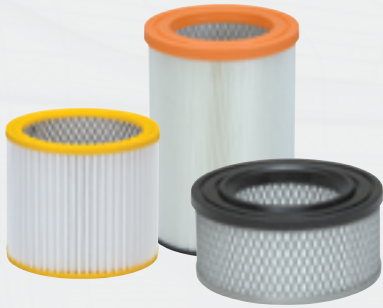

HEPA Filtration

HEPA filters utilized in Raptor Vacs® are highly efficient and capture particulates as fine as 0.3 micron.



Breathe Fresh Air

Capturing respirable dusts created while sanding or grinding helps ensure operators are breathing clean air, contributing to a safer workplace.



Maximize abrasive life

Vacuuming sanding dust as it is being made helps prevent dust from loading on an abrasive disc or sheet enabling the abrasive to be used completely and helping prevent swirl marks.



Minimized Down Time

Easy access filters and bags used in Raptor Vacs® make maintenance simple and quick. The Mini-Raptor Vac® power unit can be easily replaced at the end of the motor service life, in under 15 minutes.



Certified Equipment

Breathe easy knowing the Dynabrade full line of clean air solutions are certified to meet each area of collection, including aluminum dust.



Vacuum Tools

Dynabrade has pioneered the use of portable air tools with vacuums. All compatible tools can be found on our new web page and in a full catalog dedicated to clean air tools and equipment.



MINI-RAPTOR VAC® PACKS MOBILE AUTOMOTIVE VACUUM SYSTEMS

Designed for peak efficiency, the Pro-Pack equips a single operator with a complete system for sanding and dust collection. Featuring a Vacuum Auto On/Off, the Premium Pack saves time and energy by automatically turning suction on and off with tool use.

PREMIUM PACK

FEATURES

- ▶ Premium cart with accessory shelf
- ▶ Tool & hose hanger
- ▶ Mini-raptor vac® auto on/off
- ▶ Industrial locking casters
- ▶ Stainless canister with HEPA filter & bag
- ▶ 6 meters vacuum hose assembly, non-conductive

TECH TIP

M-Class vacuums capture particulates 10X finer than L-Class vacuums.

RAPTOR VAC® AUTO ON/OFF

61570

- ▶ Tool use activates vacuum suction
- ▶ 1/2" Air Inlet & Outlet
- ▶ 230V



* Shown with optional 61561 Mini Raptor Vac® Single Tool Connection Kit



Model 10089

**2 YEAR
WARRANTY**



M-Class



BENEFITS



The Mini-Raptor Vac® Premium Pack provides technicians with a complete package for all their sanding, storage and mobility needs. The single tech work station seen here is easily expandable to a two-person station by adding a Y-connector and second hose. The shelf and storage containers keep additional tools and abrasives organized and close at hand, while the small footprint keeps floor space free of clutter.

STANDARD PACK

Fending off dust and creating an efficient and safe work environment begins with the Mini-Raptor Vac® – Standard Pack. The combination of Dynabrade Random Orbital Sander, Raptor Vac® and cart provides a mobile sanding solution for dusty shops.

FEATURES

- ▶ Carriage handle & dolly
- ▶ Stainless canister with HEPA filter & bag
- ▶ 6 meters vacuum hose assembly, non-conductive



For wet pickup remove dry use only filter and bag and install optional 61126 filter sleeve.



M-Class



2 YEAR WARRANTY



Model 10088

INCLUDED IN PACK



Model Number					
10088	X		X	X	
10089	X	X		X	X

COMPONENT SPECIFICATIONS



Model Number	Amp	Capacity Gallon/Liter	Watts	Water Static Lift Inch / cm/ mbar	Air Flow CFM (L/Min)	Sound Level	Height Inch (mm)	Width Inch (mm)	Length Inch (mm)
61110	5A	16 (60.5)	1050	60 / 152 / 149	115 (3,256)	82 dBA	28 (71)	21 (53)	18 (46)



Model Number	Platform Dimensions	Weight lb (kg)	Shipping Weight lb (kg)	Height Inch (mm)	Width Inch (mm)	Length Inch (mm)
61486	18" (457 mm) x 24" (610 mm)	75 (34)	89 (40)	43.5 (110)	25.3 (64)	30.7 (78)

RELATED PRODUCTS



Raptor Vac®
Auto On/Off
Page 70



Power Unit
Assembly
Page 70



Vacuum Hose
Assembly
Page 68



Swivel Adaptor
Page 62

M-CLASS VACUUM SYSTEM ELECTRIC PORTABLE VACUUM SYSTEM

Designed for general source capture and dry cleanup. For collecting dust and debris such as wood, plastics, fiberglass and body filler. Conductive stainless steel canister, for dry vacuuming only in normal locations.



FEATURES

- ▶ Vacuum starts automatically with startup of tool
- ▶ Bypass Motor System uses environmental air to cool the motor and extend vacuum life
- ▶ Heavy-duty stainless steel recovery tank, with 20 gallon (78 liters) capacity for clean filter assurance. This size allows filter to remain at substantial distance from collected debris, reducing clogging and extending motor life
- ▶ Convenient orange warning light indicates that filter needs replacement
- ▶ Self-cleaning filter system

INCLUDES

Two 20' (6 m) Conductive Coaxial Hoses with Integrated Air Lines
"Y" Connector
Two Composite Couplers
Vacuum Hose Swivel Cuff
Two Disposable Collection Bags
HEPA H13 Filter with 99.95 % efficiency on 0.3 micron

Model 61409 Series 230 V, 50 Hz, 15 Amp Plug (Europe)

**2 YEAR
WARRANTY**

CERTIFICATIONS



European Countries:



NON-CONDUCTIVE

Model Number	Country	Capacity Gallon (Liter)	Voltage/Frequency	Watts	Amp (Plug for Region)	Water Static Lift Inch / cm / mbar	Air Flow CFM (l/min)	Sound Level	Ship Weight Lb. (kg)	Height In. (mm)	Width In. (mm)	Length In. (mm)
61402	UK	20 (78)	230 V / 50 Hz	1,250	5 (CCE7)	94 / 238 / 234	125 (3540)	73 dB(A)	85 (39)	48 (122)	27 (69)	24 (61)
61409NC	Europe	20 (78)	230 V / 50 Hz	1,250	5 (CCE7)	94 / 238 / 234	125 (3540)	73 dB(A)	85 (39)	48 (122)	27 (69)	24 (61)
61412	Switzerland	20 (78)	230 V / 50 Hz	1,250	5 (CCE7)	94 / 238 / 234	125 (3540)	73 dB(A)	85 (39)	48 (122)	27 (69)	24 (61)

CONDUCTIVE

Model Number	Country	Capacity Gallon (Liter)	Voltage/Frequency	Watts	Amp (Plug for Region)	Water Static Lift Inch / cm / mbar	Air Flow CFM (l/min)	Sound Level	Ship Weight Lb. (kg)	Height In. (mm)	Width In. (mm)	Length In. (mm)
61403	UK	20 (78)	230 V / 50 Hz	1,250	5 (CCE7)	94 / 238 / 234	125 (3540)	73 dB(A)	85 (39)	48 (122)	27 (69)	24 (61)
61409C	Europe	20 (78)	230 V / 50 Hz	1,250	5 (CCE7)	94 / 238 / 234	125 (3540)	73 dB(A)	85 (39)	48 (122)	27 (69)	24 (61)
61413	Switzerland	20 (78)	230 V / 50 Hz	1,250	5 (CCE7)	94 / 238 / 234	125 (3540)	73 dB(A)	85 (39)	48 (122)	27 (69)	24 (61)

Additional Specifications: Air Inlet Thread 3/8" NPT • Air Pressure 90 PSIG (6.2 bar)

PNEUMATIC WALLMOUNT AND BACKPACK VACUUM

For use on metallic surfaces, a perfect solution for the occasional capture of potentially hazardous dusts such as aluminum and commercial alloys. The included wall-mounting brackets allow for convenient storage and removal providing technicians with added mobility throughout the garage.

FEATURES

- ▶ The most cost-effective solution to metallic dust collection
- ▶ Designed for dry source capture, to be used for general maintenance in potentially hazardous locations
- ▶ Lightweight, stainless steel construction (SAE 304) handheld design provides great mobility
- ▶ Air jet is adjustable from 80" to 90" of water static lift
- ▶ Aerosol leak tested for quality assurance
- ▶ Unit is static-dissipating (kit included) and conductive
- ▶ Recovery capacity of 1.5 gallons (6 liters) in optional Disposable Filter Bag

INCLUDES

HEPA H14 Filter
 Brackets for Mounting to Wall or to Vacuum Cart
 Wall-mounting hardware
 1/2" by 2' (25 mm x 0.6 m) Conductive Air Line Supply
 Composite Coupler
 Vacuum Hose Swivel Adapter
 Three Collection Bags

CERTIFICATIONS

Designed for use in:
 Class I, Category 2, Groups A, B, C, D, T6; Class II, Category 2, Groups E, F, G
 Hazardous Locations as defined in the National Electric Code (NFPA 70)



Model 61471 Category 2 - (Europe)



Model 61473 Category 2 - (Europe)

Model Number	Capacity Gallon (Liter)	Max. Capacity Lb. (kg)	Air Inlet Pressure PSIG (Bar)	Air Consumption CFM (l/min)	Air Flow CFM (l/min)	Water Static Lift Inch / cm / mbar	Sound Level	Ship Weight Lb. (kg)	Height In. (mm)	Width In. (mm)	Length In. (mm)
61471	1.5 (6)	5 (2.3)	90 (6.2)	35 (991)*	50 (1,416)	80 / 203 / 199	68 dB(A)	28 (13)	16 (41)	18 (46)	30 (76)
61473	1.5 (6)	5 (2.3)	90 (6.2)	35 (991)*	50 (1,416)	80 / 203 / 199	68 dB(A)	28 (13)	16 (41)	18 (46)	30 (76)

*NOTE: Be sure to add air consumption for EACH TOOL attached to Vacuum, for total CFM (l/min) requirement.

RELATED PRODUCTS



ROS Sanders
Pages 26-32



Cleaning Kit
Page 68



Optional Vacuum Hose Assembly
Page 68



Vacuum Bags
Page 69

COMPACT IMMERSION VACUUM SYSTEM ELECTRIC AND PNEUMATIC PORTABLE VACUUMS



For collecting metallic dust & debris such as aluminum and commercial alloys. Collects and renders inert up to a maximum of 5 lbs. (2.27 kg) of dust.

FEATURES

- ▶ Legally certified explosion proof / dust ignition proof by an OSHA approved Nationally Recognized Testing Laboratory (NRTL)
- ▶ Coalescing Filter Element (CFE) for moisture removal
- ▶ Degassing Vent allows gas to be evacuated automatically from the unit
- ▶ Vacuums and included tool kit are static-dissipating and conductive
- ▶ Corrosion resistant Stainless steel recovery tank

ELECTRIC AND PNEUMATIC VACUUMS INCLUDE:

- One 20' (6 m) Conductive Coaxial Hoses with Integrated Air Lines
- One Composite Coupler
- One Vacuum Hose Swivel Adapter
- Conductive Collection Bag
- HEPA H14 Filter with 99.995% efficiency on 0.3 micron

PNEUMATIC VACUUM for use in:

- Group A** atmospheres, containing acetylene
- Group B** atmospheres, containing flammable gas, flammable liquid-produced vapor, or combustible liquid-produced vapor mixed with air
- Group C** atmospheres, containing flammable gas, flammable liquid-produced vapor, or combustible liquid-produced vapor mixed with air

ELECTRIC and PNEUMATIC VACUUM for use in:

- Group D** atmospheres, containing flammable gas, flammable liquid-produced vapor, or combustible liquid-produced vapor mixed with air that may burn or explode
- Group E** atmospheres, containing potentially combustible dusts, including aluminum, magnesium, and their commercial alloys
- Group F** atmospheres, containing combustible carbonaceous dusts, such as coal, carbon black, charcoal, coke dust
- Group G** atmospheres, containing wood and plastic dusts

Model Number	Regional Description	Capacity Gallon (liter)	Dust Recovery Pound (kg)	Voltage/Frequency	Watts	Amp (Plug for Region)	Water Static Lift Inch / cm / mbar	Air Flow CFM (L/min)	Sound Level	Height In. (cm)	Width In. (cm)	Length In. (cm)
61511	ATEX Cat. 2 for Zones 1 & 21	6.25 (24)	5 (2.27)	220-240 V / 50-60 Hz	1,000	13 (UK)	69 / 175 / 172	132 (3,738)	85 dB(A)	43 (109)	26 (66)	26 (66)

Additional Specifications: Air Pressure 90 PSIG (6.2 bar) • Ship Weight 179 lb. (81 kg)

Model Number	Regional Description	Capacity Gallon (liter)	Dust Recovery Pound (kg)	Air Consumption CFM/(L/min)	Air Flow CFM/(L/min)	Water Static Lift Inch / cm / mbar	Sound Level	Height In. (cm)	Width In. (cm)	Length In. (cm)
61512	ATEX Cat. 2 for Zones 1 & 21	6.25 (24)	5 (2.27)	45 (1,274)*	110 (3,115)	180 / 457 / 448	80 dB(A)	48 (122)	22 (56)	20 (51)

Additional Specifications: Air Pressure 90 PSIG (6.2 bar) • Ship Weight 168 lb. (76 kg)

*NOTE: Be sure to add air consumption for EACH TOOL attached to Vacuum, for total CFM (L/Min) requirement.

BENEFITS



A common misconception is that metallic dust is required to be captured using a wet vacuum system. The National Fire Protection Agency states that up to 5 pounds of metallic dust can be collected in a dry state. Category 2 Raptor Vacs® are certified for DRY pickup of potentially hazardous metallic dusts, like aluminum, that are commonly found in many modern vehicles. The wall-mount Raptor Vac® provides a low cost entry point for metallic dust collection.



ATEX CERTIFIED VACUUMS

Explosion-proof and dust ignition-proof

For safe recovery of combustible and conductive dusts

2 YEAR WARRANTY



ELECTRIC

Model 61511 Category 2 - 230 V, 50 Hz (Europe)

CERTIFICATIONS



Designed for use in:
Class I, Category 2, Group D T3C
Class II, Category 2, Groups E, F and G
Hazardous Locations as defined in
the National Electric Code (NFPA 70)



European Countries:
ATEX Third Party Certified
CE EX II 2 GD Ex d IIA T3 Gb
Ex t IIIC T 200° C Db IP 6X

PNEUMATIC

Model 61512 Category 2 (Europe)

CERTIFICATIONS

Designed for use in:
Class I, Category 2, Group D T3C
Class II, Category 2, Groups E, F and G
Hazardous Locations as defined in
the National Electric Code (NFPA 70)



European Countries:
ATEX Third Party Certified
CE EX II 2 GD c IIC T6 (85° C)



COMPLETE RANGE OF SOURCE CAPTURE PRODUCTS

Available on dynabrade.com

RELATED PRODUCTS



ROS Sanders
Pages 26-32



Cleaning Kit
Page 68



Vacuum Hose
Assembly
Page 68



ACCESSORIES

Optimizing a workstation or entire garage for efficient and reliable production requires not only the right tools for the job but the right supporting accessories. Mega-flow couplers, plugs and hoses of the proper diameter and length all work to ensure the optimal volume

of air is reaching a tool, and help prevent tools from bogging down and stalling. Premium backing pads with a variety of densities and thicknesses along with contact arms of various shapes and sizes are two examples of how Dynabrade tools can be optimized to

meet the demands of a specific application. Accessories like these are details that help separate an efficient garage that moves vehicles quickly through the repair process and out to the customer, from garages that fight poor finishes and rework.

ACCESSORIES FOR OPTIMIZATION



Air tools all require specific air volume and pressure to reach their full production and efficiency potential. Using Dynabrade air delivery accessories like Mega-Flow couplers and plugs will help ensure tools do not stall under working load and operate at recommended speeds. Dynaswivels® create a “universal joint” that connects an air tool to

an airline, increasing maneuverability, reduces operator fatigue and extends hose life. Using a F-R-L will filter, regulate, and lubricate the air entering the motor chamber preserving critical components from exposure to dirt and water, ensures adequate air pressure, and increases the longevity of the air tool.

BACKING PAD INNOVATION



Backing Pads are more than a component that an abrasive disc or sheet attaches to; they are a critical component to creating the finest, most consistent surface finishes. Dynabrade random orbital Backing Pads are weight-mated to each pad diameter, reducing vibration that leads to poor finishes and ergonomic concerns for the user. The single-piece hub design is a feature pioneered by Dynabrade that further reduces

pad vibration and contributes to extended tool life and dependability. Extreme Backing Pads are the newest innovation is vacuum sanding employing a hybrid dust collection method. The teal Backing Pads utilize vacuum holes and channels that direct dusts to the center of the pad where suction and pickup is greatest, increasing abrasive life by reducing buildup.

CLEAN AIR EQUIPMENT



Capturing dust as it is being created in the sanding process is the best way to ensure airborne particulates do not become dust nibs on a newly painted surface elsewhere in a shop. HEPA filtration is utilized in all dry Dynabrade Raptor Vacs® and helps ensure that even very fine dusts are captured before they can settle and contaminate a work piece,

be inhaled by a technician, or cause a fire or explosion in the case of some metallic dusts found in modern vehicles. With integrated or available Auto On/Off features Raptor Vacs® help keep technicians productive by only operating as a tool is being used and also help reduce noise and energy consumption within the shop.

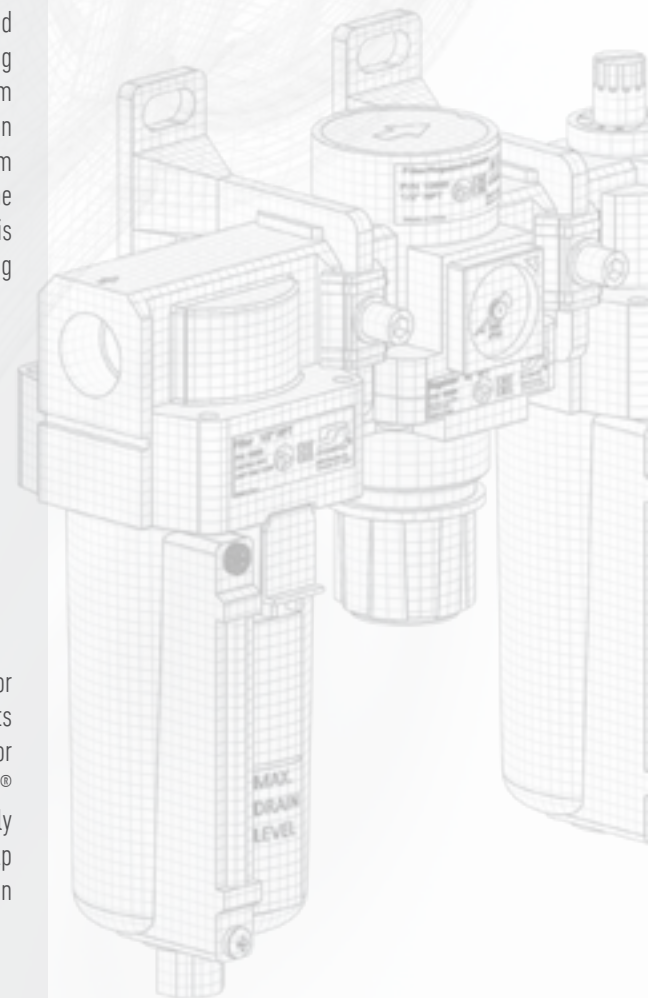

FILTER/REGULATOR/LUBRICATOR

Using a Dynabrade FRL at every work station will extend the service life of the tools at an operator's bench. An FRL will filter debris/water hidden inside air lines, allow operators to regulate air pressure locally, and deliver air tool oil much more consistently than a manual oiling process.

- ❶ Mounting brackets for easy installation
 - ❷ Manual filter/drain protects tools from water and contamination
 - ❸ Modular connections easily adaptable
 - ❹ Regulator and pressure gauge monitor and adjust air pressure
 - ❺ Adjustable oil drop, set drip rate based on tool consumption
 - ❻ Zinc construction for enhanced durability
- ▶ 106 SCFM for high demand tools
 - ▶ 5-micron filter
 - ▶ Includes 3/8" NPT reducer bushings
 - ▶ Use with Dynabrade Air Lube (95842)



Model Number	Inlet/Outlet Port Size	Maximum Air Pressure	Maximum Air Flow	Maximum Air Temperature
10690	1/2" NPT	150 PSIG (10.3 bar)	106 SCFM (3,000 LPM)	150° F (65° C)

AIR LINE CONNECTORS / DYNASWIVEL

Improve tool maneuverability and minimize operator fatigue with a "universal-joint". Two pivot points that swivel 360° relieve stress on the hose and hardware.

- ▶ Composite – no marring paint or clear coat
- ▶ Aluminum, Stainless Steel, Brass – durable metal construction
- ▶ Flow Control – finger-tip air-flow control dial or lever

Part Number	Thread Size	Style	Air Flow Range	Material
94300	1/4" NPT	Standard	up to 33 SCFM (935 LPM)	Composite
94407	1/4" NPT	Flow Control	up to 46 SCFM (1,303 LPM)	Composite
95460	1/4" NPT	Standard	up to 25 SCFM (708 LPM)	Aluminum & Stainless
95734	1/4" NPT	Flow Control	up to 25 SCFM (708 LPM)	Aluminum & Stainless
95756	1/4" NPT	Flow Control	up to 25 SCFM (708 LPM)	Chrome Plated Brass



94300



94407



95460



95756

COUPLER AND PLUGS

MEGA FLOW PLUGS

- ▶ Ported design delivers maximum air volume to the tool
- ▶ Durable zinc-plated steel construction
- ▶ Provides up to twice the air flow of a standard plug design

Body Size	Part Number	Thread Size NPT	Air Flow Range SCFM (LPM)
1/4"	95675	1/4" Male	up to 74 (2,095)
	95677	1/4" Female	
	96005	3/8" Male	



STEEL AND BRASS SAFETY COUPLERS

- ▶ Durable nickel-plated steel and brass construction
- ▶ Single action quick-connect by just inserting plug into coupler
- ▶ Release pressure before disconnecting

Coupler Body Size	Part Number	Thread Size NPT	Air Flow Range SCFM (LPM)
1/4"	95674	1/4" Female	up to 74 (2,095)
	95684	1/4" Male	



COMPOSITE-STYLE COUPLERS

- ▶ Easy disconnect by single push-button action
- ▶ Heavy-duty construction that is lightweight, shock-proof, low-vibration, and crush-resistant
- ▶ Composite-style design provides maximum air flow to tools

Body Size	Part Number	Thread Size NPT	Air Flow Range SCFM (LPM)
1/4"	94960	1/4" Female	up to 54 (1,529)
	94980	1/4" Male	



COUPLER AND PLUG COMBINATIONS

PLUGS WITH STEEL/BRASS SAFETY COUPLERS

- ▶ Includes one coupler and one plug
- ▶ Maximum working pressure: 150 PSIG (10 bar)
- ▶ Temperature Range: -4°F to 212°F (-20°C to 100°C)

Coupler & Plug Size	Part Number	Coupler Thread Size NPT	Plug Thread Size NPT	Air Flow Range SCFM (LPM)
1/4"	95676	1/4" Female	1/4" Male	up to 74 (2,095)
	95850	1/4" Female	1/4" Female	
	95685	1/4" Male	1/4" Male	
	95851	1/4" Male	1/4" Female	



PLUGS WITH COMPOSITE, PUSH-BUTTON COUPLERS

- ▶ Includes one coupler and one plug
- ▶ Maximum working pressure: 150 PSIG (10 bar)
- ▶ Temperature Range: -4°F to 212°F (-20°C to 100°C)

Coupler & Plug Size	Part Number	Coupler Thread Size NPT	Plug Thread Size NPT	Air Flow Range SCFM (LPM)
1/4"	94990	1/4" Female	1/4" Male	up to 74 (2,095)
	94991	1/4" Female	1/4" Female	
	94992	1/4" Male	1/4" Male	
	94993	1/4" Male	1/4" Female	



AIR HOSE ASSEMBLY : SPARK RESISTANT & ANTISTATIC

LIGHTWEIGHT AIR LINES – 8 MM I.D.

- ▶ Light Weight airline
- ▶ Includes reusable fittings, ensuring air line integrity and less pressure drop
- ▶ Narrow bending radius prevents “choking” of air tool



Part Number	Length Feet (meters)	Line I.D. Inches (mm)	Line O.D. Inches (mm)	Fittings Included	Color
70400	3	8	Male 6mm (1/4") / Male 6 mm (1/4")	Spark Resistant	Orange
70401	6				
70300	3			Antistatic	Grey
70301	6				

Other sizes or Hose only available upon request

Part Number	Connects to Inside Diameter	Connection Thread
94897	5/16" (8)	1/4" NPT Male



For further Air Supply Hose Recommendations see page 109

DYNAJET IN-LINE BLOW GUN

SAFETY TIP DESIGN

- ▶ Blow gun permanently mounted between coupler and air hose to purge air line of water and contaminants
- ▶ Durable aluminum construction, weighs only 2 oz. (.06 kg)
- ▶ Reduces line pressure down to 30 PSIG (2 bar)
- ▶ Meets O.S.H.A. requirements of special relief hole in nozzle, which limits pressure to 30 PSIG (2 Bar) when dead-ended and used on an air line of 150 PSIG (10.3 Bar) or less
- ▶ Ideal to blow debris from work surface

Part Number	Thread Size	Weight	Recommended Air Flow Range SCFM (L/Min)
94467	1/4" Female NPT	.06 kg	up to 35 SCFM (991 L/Min)

150 PSIG (10.3 bar) maximum

Proper Installation for DynaJet Blow Gun Connection

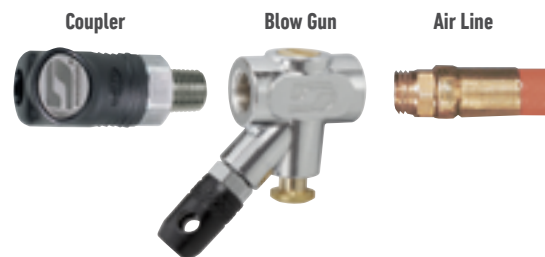

VACUUM HOSE SWIVEL ADAPTERS

Swivels for Tool Maneuverability

Part Number	Fits to internal hose diameter
96572	25 mm (1")
96573	32 mm (1-1/4")



CONTACT ARM ASSEMBLIES/PARTS

Dynabrade contact arms are available for use with 1/4" - 1/2" wide abrasive belts. More varieties allow for access in tight areas, and many unique ways to present an abrasive to the work piece. Below are the most common contact arms used in collision repair or restoration — additional options are available.

Tools Used On	Part Number	Belt Width	Wheel Diameter	Wheel Type	Platen Pad	Comments
NitroFile	11203	1/2"	5/8"	Rubber, 70 durometer	1/2" Wide, Soft	—
NitroFile	11204	1/4" or 1/2"	1"	Rubber, 70 durometer	None	Offset Design, for Slack Sanding
NitroFile	11206	5/8" or 3/4"	3/4"	Rubber, 70 durometer	3/4" Wide, Hard	—
Mini-NitroFile	15028	1/4" or 1/2"	1"	Rubber, 90 durometer	None	Offset Design, for Slack Sanding
Mini-NitroFile	15031	1/2"	7/16"	Steel	1/2" Wide, thin	13" Belts
Mini-NitroFile	15035	1/2"	5/8"	Rubber	1/2" soft	—
NitroFile	11287	5/8" or 3/4"	3/4"	Rubber	3/4" hard	—



DYNABRADE NITRO SERIES™ NITROZIP ACCESSORIES

Dynabrade Nitro Series™ NitroZip wire wheels are used for a variety of material removal and surface preparation applications from removing seam sealer to rust and paint removal. Red-Tred® Eraser wheels are ideal for removing adhesive-backed decals and pinstripping without harming the painted surface below.

WIRE AND ERASER WHEELS

Part Number	Size	Grade	Tip Type	Use
92245	4" dia. x 3/4" wide	Coarse	Bent	Sealants
92246	4" dia. x 3/4" wide	Medium	Bent	Rust
92247	4" dia. x 3/4" wide	Fine	Straight	Paint Removal
92248	4" dia. x 3/4" wide	Coarse	Bent	Sealants
92255	4" dia. x 1-1/4" wide	Aggressive Removal	—	Decals/Adhesive
92240	4" dia. x 1-1/4" wide	Light Removal	—	Decals/Adhesive



DECAL REMOVAL AND ERASER WHEEL

Decal Removal Wheel – 4" diameter x 1 1/4" wide

Model 92255 RED-tred® Eraser wheel only

Model 92242 RED-tred® Eraser wheel with hub for use with Dynabrade Nitro Series™ NitroZip

Model 92240 Beige Eraser wheel only

Model 92252 Beige Eraser wheel with hub

WHEEL HUB ASSEMBLY

Mounts wire wheels and the 92255 Eraser Decal Removal Wheel

Model 92239 For 3/4" wide wheel

Model 92252 For 1/2" wide wheel



HOOK-FACE BACKING PADS

Dynabrade random orbital backing pads are precision engineered for ultra-smooth performance and longer life. Exclusive single-piece hub design reduces pad vibration and

ensures smooth performance. Premium urethane backing pads are perfectly weight-mated to Dynabrade tools, and achieve consistent swirl-free finishes. All Dynabrade backing pads

feature our exclusive single-piece hub design, which reduces pad vibration and ensures smooth performance.



REGULAR

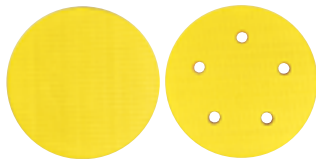

Non-Vacuum

Vacuum

Short nap pads for use with re-attachable discs. Long nap pads for use with non-woven nylon discs. Available in Non-Vacuum and Vacuum pads.

DYNAMAZE UNIVERSAL



(ø 150 mm) – model: 22290

SIMPLE, EFFECTIVE, FAST AND EASY TO USE
Universal self-gripping pad for all abrasives which match with all hole configurations due to its unique mesh system.

SUPERVAC

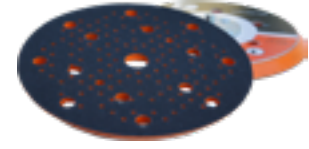

(ø 150 mm) – model: 22330

EXCELLENT CLEANUP CAPACITY
The self-gripping pad includes 132 holes and 15 holes in the standard position. For use with self-gripping abrasive discs with a mesh structure. Excellent for all perforation types.

GEAR-DRIVEN BACKING PADS

HOOK-FACE | NON-VACUUM PADS

Part Number	Diameter Inch (mm)	Thickness Inches (mm)	Holes	Max. RPM	Screws
57760	5 (125)	3/8 (10)	—	12,000	5
57764	6 (150)	3/8 (10)	—	12,000	5
56236	8 (200)	1/2 (13)	—	10,000	5

HOOK-FACE | VACUUM PADS

Part Number	Diameter Inch (mm)	Thickness Inches (mm)	Holes	Max. RPM	Screws
57765	6 (150)	3/8 (10)	6	12,000	5
56237	8 (200)	1/2 (13)	8	10,000	5



RANDOM ORBITAL SANDER BACKING PADS

HOOK-FACE | NON-VACUUM PADS

Part Number	Diameter Inch (mm)	Thickness Inches (mm)	Holes	Density	Nap
56087	3 (75)	5/8 (16)	-	Medium	Short
54325	5 (125)	3/8 (10)	-	Medium	Short
54327	6 (150)	3/8 (10)	-	Medium	Short
56158	6 (150)	3/8 (10)	-	Soft	Short
56236	8 (200)	3/8 (10)	-	Medium	Short
22305	3 (75)	5/8 (16)	-	Medium	Short

HOOK-FACE | VACUUM PADS

Part Number	Diameter Inch (mm)	Thickness Inches (mm)	Holes	Density	Nap
54326	5 (125)	3/8 (10)	5	Medium	Short
54334	5 (125)	3/8 (10)	17	Medium	Short
54328	6 (150)	3/8 (10)	6	Medium	Short
54339	6 (150)	3/8 (10)	17	Medium	Short
56327	8 (200)	3/8 (10)	8	Medium	Short
56142	3 (75)	1/2 (13)	5	Medium	Short
22306	3 (75)	1/2 (13)	6	Medium	Short
22602	6 (150)	3/8 (10)	6	Soft	Short
22603	6 (150)	3/8 (10)	17	Medium	Short



More backing pads available on dynabrade.com

DYNAMAZE UNIVERSAL VACUUM BACKING PADS (MATCH ALL ABRASIVE HOLE CONFIGURATIONS)

Part Number	Diameter	Thickness	Thread	Density
22293	5" (125 mm)	10 mm	5/16"-24	Medium
22294		16 mm	5/16"-24	Soft
22297		10 mm	M8	Medium
22298		16 mm	M8	Soft
22290		10 mm	5/16"-24	Medium
22291	6" (150 mm)	16 mm	5/16"-24	Soft
22295		10 mm	M8	Medium
22296		16 mm	M8	Soft
22299		10 mm	5 screws	Medium
22292		8" (200 mm)	10 mm	5/16"-24



SUPERVAC MULTIHOLE BACKING PADS

Part Number	Diameter	Thickness	Holes	Thread	Density
22330	6" (150 mm)	10 mm	132	5/16"-24	Medium

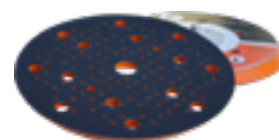

DYNALINE INLINE SANDER BACKING PADS

HOOK-FACE | NON-VACUUM PADS

Part Number	Pad Dimensions Inch (mm)	Thickness Inches (mm)	Nap	Screws
57456	2 3/4" x 8" (70 mm x 200 mm)	3/8 (10)	Short	2
57471	2 3/4" x 8" (70 mm x 200 mm)	3/8 (10)	Long	2
57513	2-3/4" x 11" (70 mm x 280 mm)	3/8 (10)	Short	2



HOOK-FACE | VACUUM PADS

Part Number	Pad Dimensions Inch (mm)	Thickness Inches (mm)	Nap	Screws
57457	2 3/4" x 8" (70 mm x 200 mm)	3/8 (10)	Short	6

DYNABUG® SANDING BACKING PADS

HOOK-FACE | NON-VACUUM PADS

Part Number	Pad Dimensions Inch (mm)	Thickness Inches (mm)	Nap	Screws
57851	3 2/3" x 7" (93 mm x 180 mm)	3/8 (10)	Short	4
57852	3 2/3" x 7" (93 mm x 180 mm)	3/8 (10)	Long	4



HOOK-FACE | VACUUM PADS

Part Number	Pad Dimensions Inch (mm)	Thickness Inches (mm)	Nap	Screws
57856	3 2/3" x 7" (93 mm x 180 mm)	3/8 (10)	Short	4

DYNABUG® II BACKING PADS

3/8" (10 mm) thick, medium density pads mount with four screws.

HOOK-FACE NON-VACUUM PADS

Model Number	Pad Dimensions Inch (mm)	Thickness Inches (mm)	Holes	Screws
56315	3" x 4 1/4" (74 mm x 109 mm)	3/8 (10)	—	4
56317	3 1/4" x 5" (80 mm x 125 mm)	3/8 (10)	—	4
56331	4-1/4" x 4-1/2" (106 mm x 114 mm)	3/8 (10)	—	4

HOOK-FACE | VACUUM PADS

Model Number	Pad Dimensions Inch (mm)	Thickness Inches (mm)	Holes	Screws
56326	2 3/4" x 7 3/4" (68 mm x 196 mm)	3/8 (10)	8	4
56316	3" x 4 1/4" (74 mm x 109 mm)	3/8 (10)	4	4
56323	99 mm x 143 mm (Delta-style)	3/8 (10)	—	4

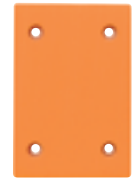

DYNAFOAM INTERFACE BACKING PADS

Interface pads attach between Backing Pad and Hook-Face abrasive. Soft foam increases conformability allowing operator to easily follow contours. Converts standard pad into a fine finishing and finessing pad.

FOR RANDOM ORBITAL SANDERS

Part Number	Diameter Inch (mm)	Thickness	Holes	Density	Attachment
53974	3" (75 mm)	13 mm	0	Soft	Standard Hook Face
22873	3" (75 mm)	7 mm	6	Hard	Standard Hook Face
22874	3" (75 mm)	7 mm	0	Hard	Micro Hook-Face
53976	3 1/2" (89 mm)	13 mm	0	Soft	Standard Hook Face
53978	5" (125 mm)	13 mm	5	Soft	Standard Hook Face
22877	5" (125 mm)	5 mm	8 + 1	Medium	Micro Hook-Face
22878	5" (125 mm)	5 mm	8 + 1	Soft	Micro Hook-Face
53980	6" (150 mm)	13 mm	6	Soft	Standard Hook Face
53965	6" (150 mm)	13 mm	21	Soft	Standard Hook Face
22872	6" (150 mm)	5 mm	15	Soft	Micro Hook-Face
22876	6" (150 mm)	5 mm	15	Medium	Micro Hook-Face
53982	8" (200 mm)	13 mm	8	Soft	Standard Hook Face

FOR DYNALINE & DYNABUG® SANDERS

Part Number	Diameter Inch (mm)
53984	2 3/4" (70 mm) x 11" (280 mm) For the Dynaline
53986	2 3/4" (70 mm) x 8" (200 mm) For the Dynaline
53988	3 2/3" (93 mm) x 7" (180 mm) For the Dynaline and Dynabug®

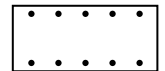
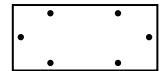
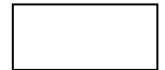

VACUUM ACCESSORIES

Each cleaning kit includes an extension hose and variety of attachments used for general shop cleanup and dust collection in hard-to-reach areas. Specialized conductive and Division 1 Certified cleaning kits protect technicians from static discharge and acceptably capture aluminum dusts.

MINI-RAPTOR VAC® CLEANING KIT

Model 96605

For models 10088 and 100891
Vacuum Hose, 8 ft. (2.5 m) x 2.5"



CONDUCTIVE CLEANING KIT

Model 96607

For models 10088, 10089 and, 61409
Vacuum Hose, 10 ft. (3 m) length



RAPTOR VAC® DIVISION 1 CLEANING KIT

Model 96606

For models 61511 and 61512
Vacuum Hose, 10 ft. (3 m) length



WALL-MOUNTED RAPTOR VAC® DIVISION 1 CLEANING KIT

Model 62831

For model 61471
Vacuum hose, 20 ft. (6 m) length

Model 62832

Vacuum hose, 8 ft. (2.5 m) length available upon request



1" ERGONOMIC VACUUM HOSE ASSEMBLY

Model 31972

Conductive vacuum hose with integrated air line
20 ft. (6 m) length
(1) 1/4" NPT coupler
(2) 1/4" NPT plugs
Mesh protective over-hose

Model 61982

Non-conductive hose assembly



VACUUM HEPA AND WET FILTERS

Part 61122

- ▶ For use with Mini-Raptor Vac® 61100
99.95% efficiency on 0.3 micron

Part 61126

- ▶ Wet collection sleeve for use with
Mini-Raptor Vac® 61100

Part 62415

- ▶ For use with Wall-Mount Raptor Vac® 61470

Part 80459

- ▶ For use with Raptor Vac® 61421

Part 61907

- ▶ For use with Raptor Vac® Compact
Immersion 61495 and 61496

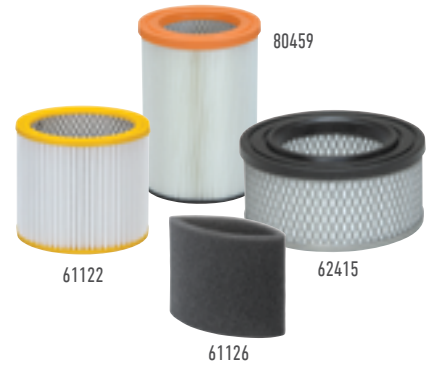

VACUUM BAGS & LINERS

Part 61125

- ▶ Disposable HEPA replacement bag for use with Mini-Raptor Vac®

Part 62787

- ▶ Collection bag 3-pack for pneumatic back-pack wall mount 61471 / 61473

Part 96623

- ▶ Collection bag 5-pack for M-Class 61409 Series, 61402, 61403, 61408, 61412, 61413

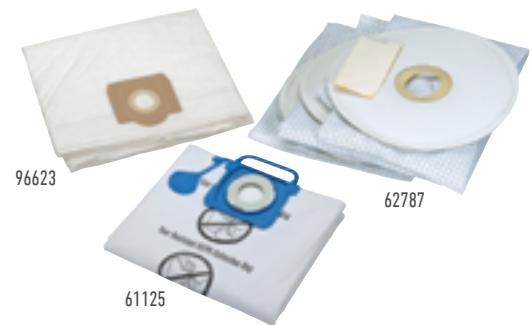

VACUUM PRE-FILTERS

Part 62778

- ▶ For use with Wall-Mount Raptor Vac® 61470

Part 31968

- ▶ Y Inlet adapter for M-Class 61402, 61403, 61408, 61409, 61412 and 61413



CONDUCTIVE & GROUNDED ACCESSORIES

Part 62449

- ▶ Grounded air line for use with Raptor Vac® 61495
and 61496

Part 61166

- ▶ Mini-Raptor Vac® Conductive Grounding Kit for
use with single inlet connection

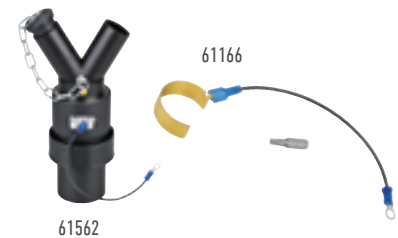

ADDITIONAL VACUUM ACCESSORIES

MINI-RAPTOR VAC® AUTO ON/OFF (230 V)

Part 61570

- ▶ Auto On/Off available upon request for Mini-Raptor Vac® Packs
- ▶ Tool use activates vacuum suction
- ▶ 230V



SYSTAINER BOX SYSTEMS

Available for Mini-Raptor Vac® Packs

Part 61502 4 in. (100 mm) tall box

Part 61503 6 in. (150 mm) tall box

Part 61505 Mounting Kit

- ▶ Single compartment stack & lock storage boxes
- ▶ Mounting Kit prevents tipping and sliding

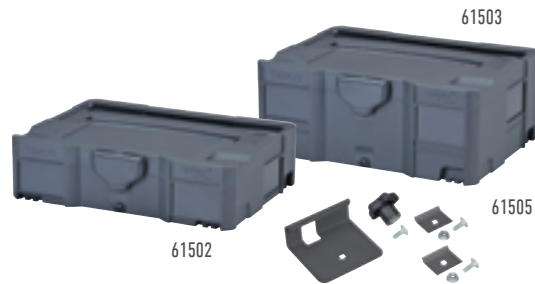

MINI-RAPTOR VAC® POWER UNIT ASSEMBLY

Part 61186

- ▶ User friendly power unit replacement, for quick and easy replacement



SAFETY COUPLER

Model 22628

- ▶ 320 Profile - 1/2" BSPT Male NBR+



AIR Y-CONNECTOR

Part 61564

- ▶ Connect two tools to vacuum auto on/off simultaneously



TOOL/VAC HOSE HANGER

Part 61506

- ▶ Storage of second tool and vacuum hose



LUBRICANTS AND GREASE

DYNABRADE AIR LUBE (10W/NR)

- Part 95821** 4 oz. (118 ml)
- Part 95842** 1 pt. (473 ml)
- Part 95843** 1 gal. (3.8 l)
- Part 96101** Display Box
24 – 4 oz. (118 ml) bottles

- ▶ Formulated for pneumatic equipment
- ▶ Absorbs up to 10% of its weight in water
- ▶ Prevents rust and formation of gum/sludge and extends time between recommended maintenance



96101



95842

GEAR OIL

- Part 95848** 2.5 oz. (74 ml) Tube

- ▶ Formulated for Dynabrade geared tools utilizing a wick-type lubrication system
- ▶ Apply every 8 hours of operation into tool's lubrication fitting
- ▶ Easy to apply using Dynabrade P/N 95541 Grease/Oil Gun



95848

GEAR GREASE

- Part 95544** 2.5 oz. (74 ml) Tube

- ▶ Apply every 50 hours of use
- ▶ Easy to apply using with Dynabrade P/N 95541 Grease/Oil Gun



95544

ULTRA GEAR GREASE

- Part 96664** 45 g Tube

- ▶ High-performance grease
- ▶ Extends gear life over conventional lithium grease
- ▶ Use on planetary gears and right angle gears



96664

PUSH-TYPE OIL OR GREASE APPLICATOR

- Part 95541**

- ▶ Can be used with Gear Oil, Gear Grease and Ultra Gear Grease



95541



ABRASIVES

Dynabrade abrasives are a key component to a total solution of tools, abrasives and accessories that deliver the lowest cost for the collision repair process. Dynabrade has a complete range of abrasives that optimize common operations technicians are confronted with like complete vehicle tear down, or damage repair and defect removal, body prep, painting and detailing.

Dynabrade offers multiple abrasive tiers for virtually every application. The broad selection meets the needs of all types and sizes of body shops with the specific goal of driving down overall costs by reducing labor and rework; while moving vehicles quickly and efficiently through the repair process and back to the owner.

The Dynabrade total solution approach will provide significant cost savings in comparison to traditional methods of collision repair or vehicle restoration based on a reduction in abrasives spend and usage, labor and time to complete each task.

ABRASIVES THAT PROVIDE RESULTS



DG 922 Film Discs

The smooth, high-performance, film backing provides the most uniform finish while the sharp free cutting abrasive and clog free coating cuts fast and eliminates pilling of body filler, primer and paint for maximum performance.



Clog Free Soft Film Discs

Part of the Dynabrade Finishing system the ultra-flexible, precision coated, clog free soft film discs products generate a defect-free, perfectly flat surface when damp or dry sanding clear coat prior to compounding and buffing.



DC 242 Coated Abrasives and Surface conditioning Belts

Dynaflex® belts are the ideal time savings solution for a myriad of applications in the body shop. From quick and easy spot weld removal for faster tear down, to weld grinding and blending on repairs, as well as blending and finishing exposed components prior to powder coating or chrome.



Buffing Pads and Compounds

The Dynabrade 2-Step finishing system optimizes the process of paint correction and polishing from up to 4 or 5 steps with conventional abrasives, compounds and pads; to a 2-step process for delivering a high-gloss and hologram-free finish. Whether using a rotary, gear-driven or random orbital tool the Dynabrade 2-step system delivers optimum results in less time.

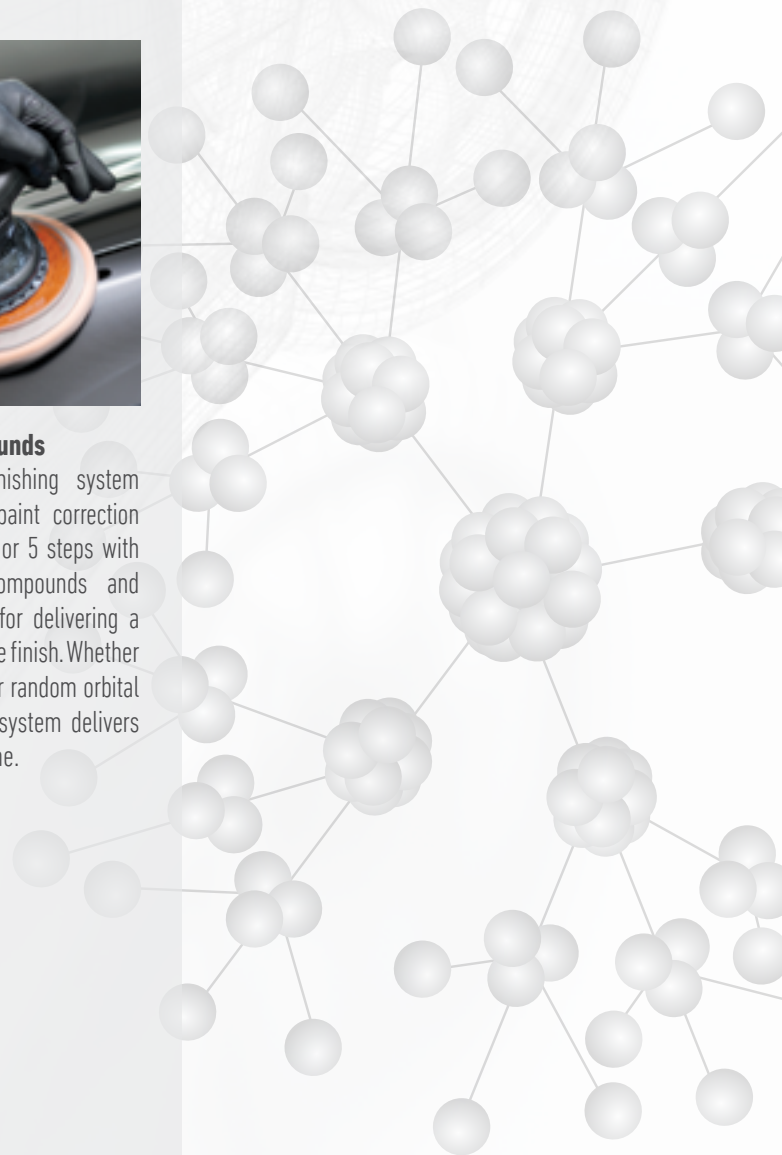

FILM / PAPER DISCS, DISC ROLLS AND SHEETS

At Dynabrade we listen, we observe, and we optimize. There are a wide variety of sanding and finishing applications in today's modern body, fabrication and detail shops. Dynabrade offers a full selection of premium performance film and paper backed

discs and sheets providing an optimum solution for virtually any sanding and finishing application. DV 722 Sanding and Finishing abrasives include hook-face discs and sheets. These sanding and finishing abrasives are commonly used for stripping

paint, sanding plastics, fiberglass and composites, leveling and blending body filler, feather edging and sanding primer, color and clear coat.

DV722 COATED ABRASIVE DISCS & SHEETS – ALUMINUM OXIDE – C/B WEIGHT PAPER BACKING

APPLICATIONS

- ▶ Surface sanding on any type of wood, metal, composite, solid surface, filler, e-coat, primer, paint coat, clear coat and gel coat

FEATURES

- ▶ Anti-loading stated topcoat provides long life and good cut rate without wild scratches
- ▶ Open coat of Aluminum oxide grain for less clogging
- ▶ Suitable for grinding new generation water based lacquers

BENEFITS

- ▶ Resinoid bonding ensures excellent performance and durability
- ▶ Excellent dust reduction with vacuum dust extraction system for a safe and work-friendly environment

INFORMATION

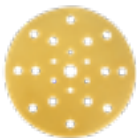

Diameter	Grit	Holes	Attachment	P/N	Qty/Box
75 mm	80	6	Hook-Face	22239	50
	100			22241	
	120			22258	
	150			22259	
	180			22260	
	240			22261	100
	320			22262	
	400			22263	
	600			22264	
	800			22265	
150 mm	60	21	Hook-Face	24644	50
	80			24645	
	100			24646	
	120			24647	100
	150			24648	
	180			24649	
	220			24650	



EXAMPLE WITH : 59109

DV722 COATED ABRASIVE DISCS & SHEETS – ALUMINUM OXIDE – C/B WEIGHT PAPER BACKING

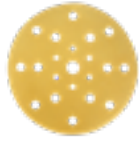

Diameter	Grit	Holes	Attachment	P/N	Qty/Box
150 mm	240	21	Hook-Face	24651	100
	280			24652	
	320			24653	
	360			24654	
	400			24655	
	500			24656	
	600			24657	
	800			24658	
150 mm	60	6 + 1	Hook-Face	24682	50
	80			24683	
	100			24684	
	120			24685	
	150			24686	100
	180			24687	
	220			24688	
	240			24689	
	280			24690	
	320			24691	
	360			24692	
	400			24693	
	500			24694	
	600			24695	
800	24696				
150 mm	60	0	Hook-Face	24629	50
	80			24630	
	100			24631	
	120			24632	
	150			24633	100
	180			24634	
	220			24635	
	240			24636	
	280			24637	
	320			24638	
	360			24639	
	400			24640	
	500			24641	
	600			24642	
800	24643				



EXAMPLE WITH : 56830



EXAMPLE WITH : X62V



EXAMPLE WITH : 59040



EXAMPLE WITH : 58405

DV722 COATED ABRASIVE DISCS & SHEETS - ALUMINUM OXIDE - C/B WEIGHT PAPER BACKING

Diameter	Grit	Holes	Attachment	P/N	Qty/Box		
	80 x 130 mm	180	Hook-Face	22595	100		
		240		22572			
		320		22593			
		400		22618			
		500		22619			
	80 x 130 mm	80	Hook-Face	22266	50		
		120		22267	100		
		180		22268			
		240		22269			
		320		22270			
	70 x 198 mm	80	Hook-Face	22231	50		
		120		22232	100		
		180		22233			
		240		22234			
		320		22235			
	400	22236					
	95 x 175 mm	80	Hook-Face	22207	50		
		120		22208	100		
		180		22209			
		240		22210			
		320		22211			
	400	22212					
	100 x 150 mm	80	Hook-Face	22225	50		
		120		22226	100		
		180		22227			
		240		22228			
		320		22229			
	83 x 83 x 83 mm	80	Hook-Face	22219	50		
				120	22220		100
				180	22221		
				240	22222		
				320	22223		
		400	22224				
		80	Hook-Face	22213	50		
		120		22214	100		
		180		22215			
		240		22216			
	320	22217					
	400	22218					

DV722 COATED ABRASIVE DISCS & SHEETS – ALUMINUM OXIDE C/B WEIGHT PAPER BACKING

Diameter	Grit	Holes	Attachment	P/N	Qty/Box
62 x 98 mm	80	0	Hook-Face	22012	50
	120			22026	
	180			22028	
	320			22032	
	400			22034	
	80	6		22039	50
	120			22041	
	180			22043	
	320			22205	
	400			22206	
500	0	22036	100		
70 x 198 mm	120	10		22237	
62 x 98 mm	100	0	Hook-Face	22328	100
	240			22329	
	240	6		22355	
100 x 150 mm	400	7	Hook-Face	22356	100
80 x 400 mm	60	14	Hook-Face	22384	100
	80			22385	
	120			22386	
	180			22387	
	240			22388	
	320			22389	
	60			14	
80	22391				
120	22392				
180	22393				
240	22394				
115 x 280 mm	320	10	Hook-Face	22395	100
	60			22464	
	80			22465	
	120			22466	
	180			22467	
240	22468				
320	22469				

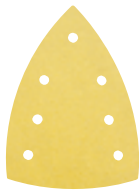

EXAMPLE WITH : 58015



EXAMPLE WITH : 58506



EXAMPLE WITH : 58550



EXAMPLE WITH : 57404

DG922 COATED ABRASIVE DISCS – ALUMINUM OXIDE FILM BACKING

APPLICATIONS

- ▶ Surface sanding on any type of wood, metal, composite, solid surface, filler, e-coat, primer, paint coat, clear coat and gel coat

FEATURES

- ▶ Aluminum oxide mineral together with film backing gives a very controlled and even sanding property
- ▶ Easily convertible from paper disc for better quality and longer life. Ideal for both dry and wet applications.

BENEFITS

- ▶ Polyester film backing allows long-lasting application time and better resistant to tear-off in difficult corners
- ▶ Anti-loading treatment greatly enhances the life of the product and also improves work piece finish
- ▶ Film works better than paper with uniform mineral coating on perfectly even film surface

INFORMATION



Diameter	Grit	Holes	Attachment	P/N	Qty/Box
75 mm	1000	0	Hook-Face	22956	100
	1500			22556	
	2000			22474	
75 mm	40	6	Hook-Face	73147	100
	60			73148	50
	80			73820	100
	100			73821	
	120			73822	
	150			73823	
	180			73824	
	220			73825	
	240			73826	
	280			73113	
	320			73114	
	400			73115	
	500			73116	
	600			73117	
	800			73827	
	1000			73828	
	1200			73829	
1500	73830				
2000	73831				
89 mm	40	0	Hook-Face	73720	50
	60			73721	



EXAMPLE WITH : X32



EXAMPLE WITH : 59109

DG922 COATED ABRASIVE DISCS - ALUMINUM OXIDE FILM BACKING



Diameter	Grit	Holes	Attachment	P/N	Qty/Box
89 mm	80	0	Hook-Face	73722	100
	100			73723	
	120			73724	
	150			73725	
	180			73726	
	220			73727	
	240			73728	
	280			73729	
	320			73730	
	360			73349	
	400			73731	
	500			73119	
	600			73732	
	800			73141	
	1000			73142	
	1200			73143	
	1500			73144	
2000	73145				
125 mm	40	0	Hook-Face	73520	50
	60			73521	
	80			73522	
	100			73523	
	120			73524	
	150			73525	
	180			73526	
	220			73527	
	240			73528	
	280			73529	
	320			73530	
	400			73531	
	500			73533	
	600			73534	
	800			73535	
	1000			73536	
	1200			73537	
1500	73538				
2000	73539				
125 mm	40	8+8+1	Hook-Face	73988	50
	60			73989	
	80			73295	100
	100			73946	
	120			73947	



EXAMPLE WITH : 59000





EXAMPLE WITH: X51H



EXAMPLE: 59024

DG922 COATED ABRASIVE DISCS ALUMINUM OXIDE - FILM BACKING

Diameter	Grit	Holes	Attachment	P/N	Qty/Box
 125 mm	150	8+8+1	Hook-Face	73948	100
	180			73996	
	220			73997	
	240			73998	
	280			73999	
	320			73149	
	360			73241	
	400			73992	
	500			73993	
	600			73994	
	800			73995	
	1000			73247	
	1200			73248	
	1500			73249	
	2000			73341	
 125 mm	40	8+1	Hook-Face	73620	50
	60			73621	100
	80			73622	
	100			73623	
	120			73624	
	150			73625	
	180			73626	
	220			73627	
	240			73628	
	280			73629	
	320			73630	
	360			73647	
	400			73631	
	500			73648	
	600			73632	
 150 mm	40	8+6+1	Hook-Face	73120	
	60			73121	100
	80			73122	
	100			73123	
	120			73124	
	150			73125	
	180			73126	
	220			73127	



EXAMPLE WITH: 58405



EXAMPLE WITH : 52760



EXAMPLE WITH : X61V

DG922 COATED ABRASIVE DISCS – ALUMINUM OXIDE FILM BACKING



Diameter	Grit	Holes	Attachment	P/N	Qty/Box
150 mm	240	8+8+1	Hook-Face	73128	100
	280			73129	
	320			73130	
	360			73131	
	400			73132	
	500			73133	
	600			73134	
	800			73135	
	1000			73136	
	1200			73137	
	1500			73138	
	2000			73139	
150 mm	40	0	Hook-Face	73220	50
	60			73221	
	80			73222	
	100			73223	
	120			73224	
	150			73225	
	180			73226	
	220			73227	
	240			73228	
	280			73229	
	320			73230	
	360			73231	
	400			73232	
	500			73233	
	600			73234	
	800			73235	
	1000			73236	
	1200			73237	
1500	73238				
2000	73239				
200 mm	40	8+1	Hook-Face	73320	50
	60			73321	
	80			73322	
	100			73323	
	120			73324	
	150			73325	
	180			73326	
	220			73327	
	240			73328	



EXAMPLE WITH : X61V



EXAMPLE WITH: 59040



EXAMPLE : 58660

DG922 COATED ABRASIVE DISCS - ALUMINUM OXIDE - FILM BACKING

Diameter	Grit	Holes	Attachment	P/N	Qty/Box
200 mm	280	8	Hook-Face	73329	100
	320			73330	
	360			73331	
	400			73332	
	500			73333	
	600			73334	
	800			73335	
	1000			73336	
	1200			73337	
	1500			73338	
	2000			73339	
200 mm	40	0	Hook-Face	73420	50
	60			73421	
	80			73422	
	100			73423	
	120			73424	
	150			73425	
	180			73426	
	220			73427	
	240			73428	
	280			73429	
	320			73430	
	360			73431	
	400			73432	
	500			73433	
	600			73434	
	800			73435	
	1000			73436	
	1200			73437	
	1500			73438	
2000	73439				
200 mm	40	8+6+1	Hook-Face	73633	50
	60			73634	
	80			73635	
	100			73636	
	120			73637	
	150			73638	
	180			73639	
	220			73958	
	240			73959	
	280			73735	
	320			73778	
	360			73779	



EXAMPLE WITH : 58446





EXAMPLE WITH : 58410



EXAMPLE WITH : 58414

DG922 COATED ABRASIVE DISCS & SHEETS – ALUMINUM OXIDE FILM BACKING

Diameter	Grit	Holes	Attachment	P/N	Qty/Box
 200 mm	400	8+8+1	Hook-Face	73838	100
	500			73839	
	600			73832	
	800			73957	
	1000			73834	
	1200			73835	
	1500			73836	
	2000			73837	
 80 x 400 mm	40	14	Hook-Face	22396	100
	60			22397	
	80			22398	
	120			22399	
	180			22457	
	240			22453	
	320			22454	
 115 x 400 mm	40	14	Hook-Face	73048	100
	60			22455	
	80			73035	
	120			73213	
	180			73036	
	240			73840	
81 x 133 mm	800	0	Hook-Face	24509	100
	1200			73945	



EXAMPLE WITH : 58414



EXAMPLE WITH : 58550

DG922 COATED DAISY DISCS – ALUMINUM OXIDE FILM BACKING

Diameter	Grit	Holes	Attachment	P/N	Qty/Box
 42 mm	60	0	Hook-Face	73316	500
	80			22569	
	120			73916	
	150			73317	
	320			73318	
	400			73319	
	600			24610	
	800			73416	
	1200			22570	
	1500			22571	
2000	73214				



EXAMPLE WITH : 58037

CLOG FREE SOFT FILM DISCS – ALUMINUM OXIDE POLYESTER BACKING

APPLICATIONS

- ▶ Surface sanding on any type of wood, metal, composite, solid surface, filler, e-coat, primer, paint coat, clear coat and gel coat

FEATURES

- ▶ Very soft and conformable polyester abrasive discs and sheets
- ▶ Very efficient anticlog treatment

BENEFITS

- ▶ Allows to achieve very fine and even surfaces, ideal preparation to polishing
- ▶ Excellent on coatings, paints, clearcoats, lacquers, ...
- ▶ For dry and wet soft sanding applications
- ▶ Works excellent with our Micro Hook-Face interface pads.

INFORMATION



Diameter	Grit	Holes	Attachment	P/N	Qty/Box
76 mm	800	0	Velcro	22479	50
	1200			24659	
	1500			24660	
	2000			24661	
	2500			24662	
	3000			24663	
125 mm	280	0	Velcro	24519	25
	320			24520	
	400			24521	
	600			24522	
	800			22363	
	1200			24523	
	1500			24524	
	2000			24525	
	2500			24526	
	3000			24527	
125 mm	320	6+1	Velcro	24528	25
	400			24529	
	600			24531	
	1200			24532	
	2000			24533	
	3000			24534	
125 mm	400	8+1	Velcro	24530	25
	500			22492	
	600			24670	
	800			22364	
	1500			24671	
	2000			22482	
	2500			22483	
	3000			24672	



EXAMPLE WITH : 59109



EXAMPLE WITH : 59039



EXAMPLE WITH : 52760



EXAMPLE WITH : X51V

CLOG FREE SOFT FILM DISCS – ALUMINUM OXIDE – POLYESTER BACKING

Diameter	Grit	Holes	Attachment	P/N	Qty/Box
	280	0	Velcro	24535	25
	320			24536	
	400			24537	
	600			24538	
	800			22365	
	1200			24539	
	1500			24542	
	2000			24543	
	2500			24544	
	3000			24545	
	400	8+6+1	Velcro	24548	25
	600			24673	
	800			22674	
	1200			24550	
	1500			24675	
	2000			24676	
	2500			24677	
	3000			24678	
	600	6+1	Velcro	24549	25
	1500			24551	
	2000			24552	
	2500			24553	
	3000			24554	
	600	0	Velcro	22484	25
	800			24679	
	1200			24559	
	1500			24560	
	2000			24561	
	2500			24562	
	3000			24563	



EXAMPLE WITH : 59029

CLOG FREE EXTREME – ALUMINUM OXIDE POLYESTER BACKING

APPLICATIONS

- ▶ Intermediate to final finish before polishing

FEATURES

- ▶ Aluminum oxide mineral together with film backing gives a very controlled and even sanding property
- ▶ Easily convertible from paper disc for better quality and longer life. Ideal for both dry and wet applications

BENEFITS

- ▶ Polyester film backing allows long-lasting application time and better resistant to tear off in difficult corners
- ▶ Anti-loading treatment greatly enhances the life of the product and also improves work piece finish
- ▶ Film works better than paper with uniform mineral coating on perfectly even film surface

INFORMATION

CLOG FREE EXTREME - ALUMINUM OXIDE - POLYESTER BACKING

Diameter	Grit	Holes	Attachment	P/N	Qty/Box
150 mm	60	0	Velcro	22530	25
	80			22531	
	100			22532	
	120			22533	
	150			22534	
	180			22535	
	220			22536	
	240			22537	
	280			22538	
	320			22539	
	360			22540	
	400			22541	
	500			22542	
	600			22543	
	800			22544	
	1000			22545	
	1200			22546	
	1500			22547	
2000	22548				
150 mm	60	8+6+1	Velcro	22511	25
	80			22512	
	100			22513	
	120			22514	
	150			22515	
	180			22516	
	220			22517	
	240			22518	
	280			22519	
	320			22520	
	360			22521	
	400			22522	
	500			22523	
	600			22524	
	800			22525	
	1000			22526	
	1200			22527	
	1500			22528	
2000	22529				
2500	24677				



EXAMPLE WITH : 59040



EXAMPLE WITH : X62V

DYNAMESH COATED ABRASIVE DISCS – ALUMINUM OXIDE VELCRO BACKING

The Dynamesh has an abrasive net, is clog resistant and long lasting.
Aluminum Oxide for excellent performances on most part of materials.

APPLICATION

► Intermediate to fine application on clogging materials.

FEATURES

► Mesh structure.

BENEFITS

► Clog resistant.

► Excellent dust extraction.



Diameter	Grit	Holes	Attachment	P/N	Qty/Box	Type
125 mm	P80	0	Velcro	23060	100	Disc
	P100			23061		
	P120			23062		
	P150			23063		
	P180			23064		
	P220			23065		
	P240			23066		
	P320			23067		
	P400			23068		
	P500			23069		
	P600			23070		
150 mm	P80	0	Velcro	22780	100	Disc
	P100			22781		
	P120			22782		
	P150			22783		
	P180			22784		
	P220			22785		
	P240			22786		
	P320			22787		
	P400			22788		
	P500			22789		
	P600			22790		
225 mm	P120	0	Velcro	22793	100	Disc
115 mm x 10 m	P80	0	Velcro	22791	1	Roll
	P120		Velcro	22792		



EXAMPLE WITH : X61

COATED ABRASIVES BELTS

Dynabrade is the company that created the first portable power tool solution for automating the grinding and finishing of difficult to reach areas, The Dynaflex®. Dynabrade's DC 242 coated

abrasive belt offering is a multi-tiered line engineered to deliver maximum benefit on virtually any application. The Dynaflex® II coupled with DC 242 belts are the ideal solution for

grinding and finishing in hard to reach areas like grinding away spot welds for faster tear down, grinding and blending welds on framing, tubing, exhaust and other components.

APPLICATIONS

- ▶ Grinding and sanding on metals, composites, plastics, wood with Dynabrade belt tools

FEATURES

- ▶ Zirconia Alumina with grinding aid grits are for heavy stock removal to intermediate finish
- ▶ Excellent on stainless steel, carbon steel, cast iron, exotic alloys, aluminum, bronze and brass
- ▶ Grinding Aid – a chemical that reduces the temperature of the working area, minimizing the risk of discoloration and deformation, in particular on stainless steel metal fabrication
- ▶ Aluminum oxide grits are for general purpose finishing applications on any kind of metals and alloys Ceramic belts suitable for high pressure grinding applications

BENEFITS

- ▶ Fast, cool cutting action provides a longer productive life
- ▶ No discoloration on stainless steel

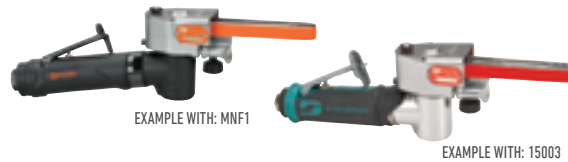

INFORMATION

DC242 COATED ABRASIVE BELTS – ALUMINUM OXIDE CLOTH BACKING

Dimensions	Grits	P/N	Qty/Box	Recommended speed
3 x 305 mm	180	70008	30	27-33m/s
	240	70009		
	320	70010		
3 x 457 mm	180	70020		
	240	70021		
	320	70022		
6 x 305 mm	180	70044		
	240	70045		
	320	70046		
6 x 457 mm	180	70056		
	240	70057		
	320	70058		

Dimensions	Grits	P/N	Qty/Box	Recommended speed
13 x 305 mm	180	70092	30	27-33m/s
	240	70093		
	320	70094		
13 x 330 mm	180	24615		
	240	24616		
	320	24617		
13 x 457 mm	180	70104		
	240	70105		
	320	70106		
19 x 457 mm	180	70128		
	240	70129		
	320	70130		
25 x 457 mm	180	70164		
	240	70165		
	320	70166		



DC242 COATED ABRASIVE BELTS – ZIRCONIA ALUMINIA CLOTH BACKING

Dimensions	Grits	P/N	Qty/Box	Recommended speed	Dimensions	Grits	P/N	Qty/Box	Recommended speed												
3 x 305 mm	60	70003	30	27-33m/s	13 x 305 mm	60	70931	30	27-33m/s												
	80	70004				80	70932														
	120	70006				120	70934														
3 x 457 mm	60	70015			30	27-33m/s	13 x 330 mm			60	24612	30	27-33m/s								
	80	70016								80	24613										
	120	70018								120	24614										
6 x 305 mm	60	70903					30			27-33m/s	13 x 457 mm			36	24501	30	27-33m/s				
	80	70904												40	24502						
	120	70906												60	70938						
6 x 457 mm	60	70910									30			27-33m/s	13 x 457 mm			80	70939	30	27-33m/s
	80	70911																120	70941		
	120	70913																36	73372		
			30	27-33m/s				19 x 457 mm	40						70951			30	27-33m/s		
									60						70952						
									80						70953						
					120	70955															
					60	70980															
25 x 427 mm	80	70981			30	27-33m/s		25 x 427 mm	80			70981	30		27-33m/s						
	120	70983					120		70983												

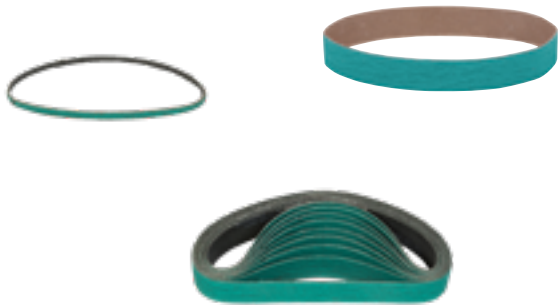

DC242 COATED ABRASIVE BELTS – CERAMIC CLOTH BACKING

Dimensions	Grits	P/N	Qty/Box	Recommended speed
13 x 457 mm	60	24624	30	27-33m/s
	80	22230		
	120	24625		



COATED ABRASIVES: FIBER DISCS

APPLICATIONS

- ▶ Removal of thick weld seams, deburring, preparation for welding on thick steel, stainless steel and titanium workpieces

FEATURES & BENEFITS

- ▶ Heavy duty fiber disc with new generation of ceramic aluminum oxide mineral with a special chemical which helps very efficiently to reduce heating in grinding applications
- ▶ Ideal for heavy stock removal to finishing on stainless steel, carbon steel, titanium, exotic alloys and bronze

INFORMATION

DYNAFIRE SANDING DISC – CERAMIC WITH GRINDING AID FIBER DISCS



Grits	P/N	Qty/Box (Sold per Pack)	Dimensions	Attachment	MOS
36	73593	100	50 mm	Locking-Type	30,000 RPM
60	73594				
80	73595				
120	73596				
36	73597	100	75 mm		
60	73598				
80	73599				
120	73670				
36	73675	100	100 mm		
60	73676				
80	73677				
120	73678				
36	73780	100	115 mm	Flange	12,000 RPM
60	73781				
80	73782				
120	73783				
36	73784	100	125 mm		
60	73785				
80	73786				
120	73787				



EXAMPLE WITH: 47821



EXAMPLE WITH: DS53

For our Zirconia/Alumina locking type fiber disc DC321 in 50 mm, 75 mm or 100 mm diameter, please refer to our Abrasive Catalogue.

BONDED ABRASIVES

APPLICATIONS

- ▶ Heavy Stock Removal and cut-off on steel/stainless steel and exotic Alloys

FEATURES

- ▶ 100% High-Performance ceramic grain abrasive
- ▶ High Strength resin and fiberglass reinforcement

BENEFITS

- ▶ Excellent cut rate
- ▶ Fast, cool cutting action provides a longer productive life
- ▶ 3-5 times the life of conventional aluminum oxide cut-off wheels

GRINDING WHEELS – CERAMIC TYPE 27



Size	Grit	P/N	MOS	Qty/Box
115 mm x 7.0 mm x 22 mm	24	22566	13.300 RPM	5
125 mm x 7.0 mm x 22 mm		22567	12.250 RPM	
230 mm x 7.0 mm x 22 mm		22568	6.650 RPM	



EXAMPLE WITH : 52633

CUT-OFF DISCS – ALUMINUM ZIRCONIA TYPE 1



Size	Grit	P/N	MOS	Qty/Box
75 mm x 1.0 mm x 10 mm	46	23368	20.000 RPM	100
100 mm x 1.0 mm x 10 mm		24668	15.000 RPM	25



EXAMPLE WITH : 54732

CUT-OFF DISCS – CERAMIC TYPE 1



Size	Grit	P/N	MOS	Qty/Box
115 mm x 1,3 mm x 22 mm	60	22613	12.000 RPM	15
125 mm x 1,3 mm x 22 mm		22614	12.000 RPM	
230 mm x 2.0 mm x 22 mm		22615	6.000 RPM	



EXAMPLE WITH : 52580

DYNASAF STRUCTURED ABRASIVES – SILICON CARBIDE FOAM BACKING

Very fine grits structured abrasives for finishing applications with foam backing hook face

APPLICATIONS

- ▶ Final finish and preparation to polishing
- ▶ Excellent for dry and wet sanding applications

FEATURES

- ▶ Soft structure
- ▶ Precise abrasive coating
- ▶ Very fine grits
- ▶ Silicon carbide

BENEFITS

- ▶ Conformable, suitable for contoured surfaces
- ▶ Even and consistent finish
- ▶ Easy to buff

INFORMATION



Diameter	Grit	Backing	P/N	Qty/Box
75 mm	P3000	Velcro	22843	15
150 mm			22842	
75 mm	P5000		22885	
150 mm			22884	



EXAMPLE WITH : 59025

DM555 SOFT SANDING DISCS – SILICON CARBIDE FOAM BACKING

APPLICATIONS

- ▶ Finishing of paints, lacquers, solid surface.

FEATURES

- ▶ Hook Face Attachment.
- ▶ Fine sanding of lacquers before polishing.
- ▶ Packed in an exclusive Dynabrade premium metal box for dust free storage.

BENEFITS

- ▶ Soft foam backing allows flexible sanding of both smooth and profiled surfaces.
- ▶ Reconditioning of conventional clear coats before polishing application.
- ▶ Soft foam backing avoids damaging of contours.
- ▶ Excellent for dry and wet sanding applications.

INFORMATION



Diameter	Grit	Holes	P/N	Qty/Box
80 mm	800	0	72925	20
	1000		72926	
	1500		72927	
	2000		72928	
	3000		72929	
150 mm	800	0	72935	10
	1000		72936	
	1500		72937	
	2000		72938	
	3000		72939	



EXAMPLE WITH : 59109



EXAMPLE WITH : 59109

NON-WOVEN ABRASIVES: DYNABRADE SURFACE CONDITIONING MATERIAL

APPLICATIONS

- ▶ Surface blending on car body panels for optimized processing, grinding down and smoothing welds
- ▶ Decorative finishing, wood sanding, deburring, cleaning, oxide removal
- ▶ Removing light edge burrs and other irregularities on the surface
- ▶ For use on stainless steel, aluminum, titanium, alloys, fiberglass and plastic

FEATURES

- ▶ Non-woven web structure for less clogging and better lifetime than ordinary coated abrasive discs
- ▶ High content of aluminum oxide

BENEFITS

- ▶ Disc can be easily changed with one turn of the locking-type system
- ▶ Greater resistance to loading due to the open structure of the discs compared to standard surface
- ▶ No slipping with the locking-type system and always central run. Less downtime for changes

INFORMATION

DS323 SURFACE CONDITIONING DISCS – ALUMINUM OXIDE NON-WOVEN NYLON

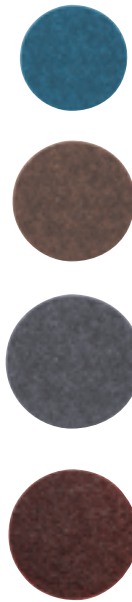

Diameter	Grit	Attachment	P/N	MOS	Qty/Box
50 mm	A-Coarse	Locking-Type	72953	23.000 RPM	50
	A-Medium		72954		
	A-Very Fine		72955		
	S-Super Fine		22616		
75 mm	A-Coarse	Locking-Type	72956	18.000 RPM	25
	A-Medium		72957		
	A-Very Fine		72958		
	S-Super Fine		22617		
100 mm	A-Coarse	Locking-Type	72959	13.000 RPM	25
	A-Medium		72960		
	A-Very Fine		72961		
115 mm	A-Coarse	Hook Face	72950	11.000 RPM	10
	A-Medium		72951		
	Very Fine		72952		
	A-Very Fine		22341		
150 mm	A-Medium	Hook Face	22342	8.500 RPM	10
	A-Very Fine		22360		
	A-Very Fine		22360		



EXAMPLE : 47821



EXAMPLE : 48530



EXAMPLE : 54430

SURFACE CONDITIONING BELTS – ALUMINUM OXIDE LOW-STRETCH NON-WOVEN NYLON

APPLICATIONS

- ▶ Satin finish and surface conditioning on metals and alloys

FEATURES

- ▶ Controlled cut does not change the workpiece geometry
- ▶ Burrs and surface oxidations are easily removed

BENEFITS

- ▶ Easily blends the wild scratches from previous working steps
- ▶ Gives consistent and easily replicable finish on metals and alloys



Dimensions	Grits	P/N	Qty/Box	MOS
6 x 305 mm	A CRS	73468	30	27 - 33 m/s
	A MED	73469		
	A VFN	73470		
6 x 457 mm	A CRS	73471	30	27 - 33 m/s
	A MED	73472		
	A VFN	73473		
6 x 610 mm	A CRS	73474	30	27 - 33 m/s
	A MED	73475		
	A VFN	73476		
13 x 305 mm	A CRS	73477	30	27 - 33 m/s
	A MED	73478		
	A VFN	73479		
	A VFN	22327		
13 x 330 mm	A CRS	24618	30	27 - 33 m/s
	A MED	24619		
	A VFN	24620		
	S SFN	24621		
13 x 457 mm	A CRS	73480	30	27 - 33 m/s
	A MED	73481		
	A VFN	73482		
15 x 457 mm	A MED	24680	10	27 - 33 m/s
	A VFN	24681		
19 x 457 mm	A CRS	73486	30	27 - 33 m/s
	A MED	73487		
	A VFN	73488		
25 x 457 mm	A CRS	73492	30	27 - 33 m/s
	A MED	73493		
	A VFN	73494		



EXAMPLE WITH : 15013



EXAMPLE WITH: MNF1



EXAMPLE WITH: 15003

NON-WOVEN ABRASIVES: OXIDE REMOVAL ABRASIVES

NOTE

- ▶ DB 357 Conforms to work area, ideal for use in automotive paint removal
- ▶ DO 379 Made of rigid open web that is aggressive and long-lasting

APPLICATIONS

- ▶ Ideal for work on stainless steel, standard or alloyed steel, aluminum, titanium, non-ferrous materials and alloys, fiberglass, plastic, stone or wood
- ▶ Aggressively removes paint and rust from welding seams, undercoating, seam-sealers and stone guards
- ▶ Applications in trunk beds and door jambs for removing sealant
- ▶ Used to remove oxidation from tire rims and rust from brake assemblies
- ▶ Removing weld blueing and oxide on stainless steel containers
- ▶ Removing of old gasket material on cylinder heads of diesel engines
- ▶ For cleaning welds and light coating removal

FEATURES

- ▶ Strong 3-dimensional synthetic fiber construction, very open, with extra-coarse silicon carbide
- ▶ High resistance to clogging and fast removal. Long lifetime; safer than wire brushes.

BENEFITS

- ▶ Conforms to work piece and does not damage the surface
- ▶ Allows access to difficult areas like wheel wells and under-carriage
- ▶ Fast removal of rust and paint without base material removal

INFORMATION

DB357 OXIDE REMOVAL ABRASIVES – SILICON CARBIDE NWN WHEELS & DISCS

P/N	Dimensions	Thickness	Attachment	Qty/Box	MOS
72962	75 mm	13 mm	13 mm Hole	10	15.000 RPM
72963			Locking-Type		
72964			6 mm Shaft		
72965	100 mm	25 mm	13 mm Hole		9.000 RPM
72966			6 mm Shaft		
72969					
72967	150 mm	25 mm	13 mm Hole		6.000 RPM
72968			8 mm Shaft		
72970					



DB379 OXIDE REMOVAL ABRASIVES – SILICONE CARBIDE NWN WHEELS & DISCS

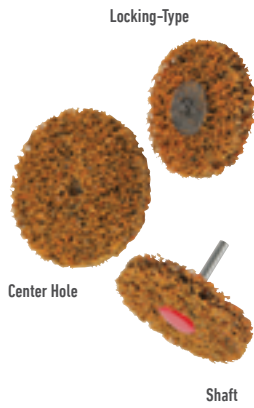

P/N	Dimensions	Thickness	Attachment	Qty/Box	MOS
72971	75 mm	13 mm	13 mm Hole	10	15.000 RPM
72973			Locking-Type		
72972			6 mm Shaft		
72974	100 mm	25 mm	13 mm Hole		9.000 RPM
72975			6 mm Shaft		
72978	150 mm	13 mm	13 mm Hole		6.000 RPM
72976			20 mm Hole		
72949			8 mm Shaft		
72977			25 mm		
72979					

SHAFT MANDREL FOR MOUNTING CENTER HOLE ABRASIVES



Diameter	P/N	Qty/Box
6 mm	72998	5

BI-METAL RECIPROCATING SAW BLADES

NOTES

- ▶ 6 Teeth per Inch: Used for demolition work in nail-embedded wood; also for fast cutting of Composites
- ▶ 10 Teeth per Inch: Used for demolition work in nail-embedded wood; also on pipe, stainless steel, carbon steel up to 6 mm thick
- ▶ 18 Teeth per Inch: Used on pipe, stainless steel, carbon steel up to 4.5 mm thick.

APPLICATIONS

- ▶ For use with Dynabrade Stockade Saws, for cutting and finishing metals, wood, plastics, carbon fibers, solid surface, etc

BENEFITS

- ▶ Shatter-resistant and excellent cut-rate

INFORMATION

BI-METAL RECIPROCATING SAW BLADES - 152 MM LONG

Teeth per Inch	Lenght x Width	P/N	Qty/Box
6	152 mm x Taper	90934	1
8	152 mm x 19 mm	90939	
18		90937	



NITRO SAW BLADES

Teeth per Inch	P/N	Qty/Box
24 Tooth Saw Blade	90928	1
32 Tooth Saw Blade	90929	









EXAMPLE WITH : RS1

DYNABURR™ CARBIDE BURRS

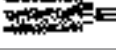
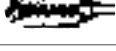
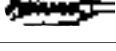
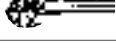
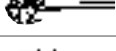
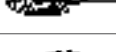
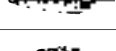
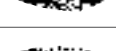
DynaBurr™ carbide burrs are used with Dynabrade die grinders for rapid material removal, precise finishing, deburring, and removal of parting lines

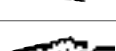
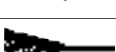
and flash. Carbide burrs provide longer life than high-speed steel burrs.

DynaBurr Shape	1/8" & 3 MM DYNABURRS, DOUBLE CUT STYLE					1/4" & 6 MM DYNABURRS, DOUBLE CUT STYLE					
	Part Number	Tool Style	Cutter Diameter	Flute Length	Shaft Size	Part Number	Tool Style	Cutter Diameter	Flute Length	Shaft Size	Package Quantity
 Cylinder	93338	SA-42	3/32"	7/16"	1/8"	93330	SA-1	1/4"	5/8"	1/4"	1
	93368	SA-42	2.5 mm	11 mm	3 mm	93360	SA-1	6 mm	16 mm	6 mm	1
 Cylinder	93339	SA-43	1/8"	9/16"	1/8"	93331	SA-3	3/8"	3/4"	1/4"	1
	93369	SA-43	3 mm	14 mm	3 mm	93361	SA-3	9 mm	19 mm	6 mm	1
 Cylinder	93340	SC-41	3/32"	7/16"	1/8"	n/a	n/a	n/a	n/a	n/a	1
	93370	SC-41	2.5 mm	11 mm	3 mm	n/a	n/a	n/a	n/a	n/a	1
 Cylinder RADIUS End	93341	SC-42	1/8"	9/16"	1/8"	93332	SC-1	1/4"	5/8"	1/4"	1
	93371	SC-42	3 mm	14 mm	3 mm	93362	SC-1	6 mm	16 mm	6 mm	1
 Cylinder RADIUS End	n/a	n/a	n/a	n/a	n/a	93333	SC-3	3/8"	3/4"	1/4"	1
	n/a	n/a	n/a	n/a	n/a	93363	SC-3	9 mm	19 mm	6 mm	1
 Ball	n/a	n/a	n/a	n/a	n/a	93334	SD-3	3/8"	5/16"	1/4"	1
	n/a	n/a	n/a	n/a	n/a	93364	SD-3	9 mm	8 mm	6 mm	1
 Ball RADIUS End	93342	SD-42	1/8"	1/8"	1/8"	n/a	n/a	n/a	n/a	n/a	1
	93372	SD-42	3 mm	3 mm	3 mm	n/a	n/a	n/a	n/a	n/a	1
 Oval	93343	SE-41	1/8"	7/32"	1/8"	93335	SE-3	3/8"	5/8"	1/4"	1
	93373	SE-41	3 mm	5.5 mm	3 mm	93365	SE-3	9 mm	16 mm	6 mm	1
 Tree	93344	SF-42	1/8"	1/2"	1/8"	n/a	n/a	n/a	n/a	n/a	1
	93374	SF-42	3 mm	13 mm	3 mm	n/a	n/a	n/a	n/a	n/a	1
 Tree RADIUS End	93345	SG-44	1/8"	1/2"	1/8"	93336	SF-3	3/8"	3/4"	1/4"	1
	93375	SG-44	3 mm	13 mm	3 mm	93366	SF-3	9 mm	19 mm	6 mm	1
 Flame POINTED End	93346	SH-41	1/8"	1/4"	1/8"	n/a	n/a	n/a	n/a	n/a	1
	93376	SH-41	3 mm	6 mm	3 mm	n/a	n/a	n/a	n/a	n/a	1
 Taper RADIUS End	93347	SL-42	1/8"	1/2"	1/8"	93337	SL-3	3/8"	1-1/16"	1/4"	1
	93377	SL-42	3 mm	13 mm	3 mm	93367	SL-3	9 mm	27 mm	6 mm	1
 14° Cone End	93348	SM-42	1/8"	7/16"	1/8"	n/a	n/a	n/a	n/a	n/a	1
	93378	SM-42	3 mm	11 mm	3 mm	n/a	n/a	n/a	n/a	n/a	1
 10° Inverted Cone	93349	SN-42	1/8"	3/16"	1/8"	n/a	n/a	n/a	n/a	n/a	1
	93379	SN-42	3 mm	5 mm	3 mm	n/a	n/a	n/a	n/a	n/a	1

n/a = Not Available.

DYNABURR™ KITS

Kits (1/8", 3 mm, 1/4" or 6 mm include one Carbide Burr of each shape, as shown above. Packaged in high-quality case.

Model Number	Burr Shaft Size	Burr Qty
93351	1/8"	12
93380	3 mm	12
93350	1/4"	8
93381	6 mm	8

For MOS and safety features, please refer to page 112.

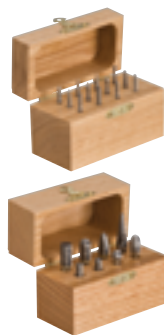

DYNACUT INOX STAINLESS STEEL BURR KIT 94020
– 5 Piece, 1/4" shank burr shapes for cutting & grinding of stainless steel



DYNACUT ALLOY SPECIFIC BURR KIT 94021
– 10 Piece, 1/8" burr shapes for cutting & grinding of nickel and titanium alloys



DYNACUT ALUMINUM & NON-FERROUS BURR KIT 94022
– 5 Piece, 1/4" shank burr shapes for cutting and grinding aluminum & other non-ferrous materials

POLISHING PRODUCTS



DYNABRADE FINISHING SYSTEM ABRASIVE TECHNOLOGY

Properly creating a high gloss surface, restoring a worn finish, or correcting defects in coatings, requires sanding to level the clear coat to with the base of the deepest scratch or defect. Using the Dynabrade Finishing System, polishing in one step can be achieved to restore a properly prepared, flat and highly reflective surface. (see Figure A)

Some compounds contain fillers and wax that will fill the defect and appear to generate a high gloss finish, but after a few washes the filler erodes and defects will re-appear. Dynabrade Finishing System compounds contain a unique, high-purity abrasive powder technology with no fillers, waxes, silicone or harmful chemicals. The unique characteristics of the high purity

abrasive allow it to begin polishing coarsely and gradually breakdown to an ultra-fine cut creating a high gloss shine or polish in one step for most colors, on all types of paints. (see Figure B) Without fillers or waxes the Dynabrade Finishing System leaves a completely smooth, flat and highly reflective surface and is easy to wipe away without leaving a residue.

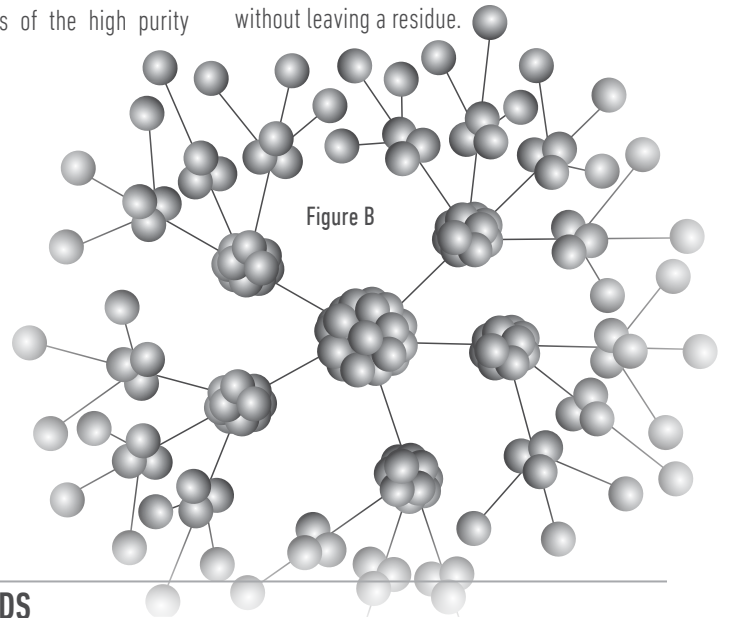
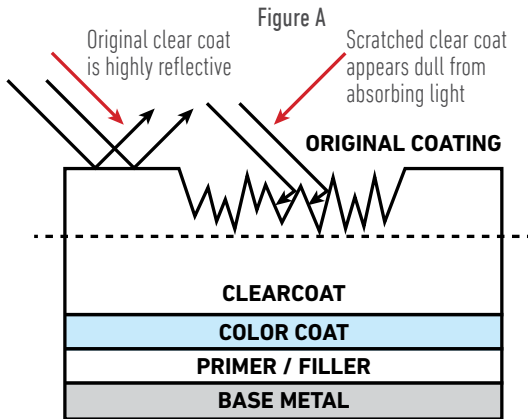

THE DYNABRADE POLISHING SYSTEM | COMPOUNDS & PADS

The Dynabrade Polishing system is based on high performance compounds that are the result of decades of research and development. Utilizing a unique abrasive powder technology,

the abrasive grain in our high-performance compounds is based on an optimized high-purity, white aluminum oxide powder. The Dynabrade system can remove defects and scratches as well

as polish surfaces in only one step, creating a brilliant mirror-like gloss. Conventional polishing compounds require a minimum of two or more polishing steps to achieve similar results.

DYNARED COARSE + FINISH

APPLICATIONS

- ▶ New generation polishing compound in coarse grade. Dynared is ideal for removing scratches from grit P1500-P2000 and finer. Gives a very good glossy finish (comparable to DynaTeal)

FEATURES AND BENEFITS

- ▶ Increase Productivity, Reduce Labor Time and Costs. Silicone Free, Enhance Final High Gloss Surface Finish
- ▶ Avoids swirl and bloom marks as well as holograms when used with our random orbital motion polishers

Container	P/N	Color	Volume
Bottle	22017	Red	1 Liter
Jug	22019	Red	5 Liters



INFORMATION

DYNATEAL FINE FINISH

APPLICATIONS

- ▶ Removes deep scratches on any kind of surface.
- ▶ Polishing compound offers an aggressive cut that can flatten soft orange-peel effect in auto aftermarket.
- ▶ Removes medium defects such as swirl marks, water spots and sanding marks.
- ▶ Can be used to prepare the car body for the subsequent high gloss surface finish application..

FEATURES AND BENEFITS

- ▶ Increase productivity, reduce labor time and costs. Silicone free, enhance final high gloss surface finish
- ▶ Avoids swirl and bloom marks as well as holograms when used with our random orbital polishers

Container	P/N	Color	Volume
Bottle	22011	Teal	1 Liter
Jug	22013	Teal	5 Liters

EXAMPLE WITH: 58456



INFORMATION

DYNAORANGE VERY FINE FINISH

APPLICATIONS

- ▶ Ideal polish for the second step of our Dynabrade "Two-Step" System when used with the corresponding foam and random orbital polisher. Leaves a high gloss, hologram free surface finish on all type of Automotive clearcoats
- ▶ Final finish operation combined with more aggressive compounds

FEATURES AND BENEFITS

- ▶ Increase productivity, reduce labor time and costs. Silicone free, enhance final high gloss surface finish
- ▶ Avoids swirl and bloom marks as well as holograms when used with our random orbital polishers

Container	P/N	Color	Volume
Bottle	22021	Orange	1 Liter

EXAMPLE WITH: 58456



INFORMATION

5 LITERS CONTAINER ACCESSORIES

DISPENSER OR HOLDER | 1 ITEM PER BOX

Product	Material	Part Number	Color
Dispenser	Plastic	22005	White
Holder	Metal	22006	-



DYNABRADE DENIBBING DISCS – SILICON CARBIDE FILM BACKING

DYNABRADE DENIBBING DISCS : FILM BACKED, SILICON CARBIDE, PSA

APPLICATIONS

- ▶ For use with Dynabrade Denibber tools in wet/damp operations to remove nibs from paint and lacquers

FEATURES

- ▶ Even and consistent tri-dimensional coating
- ▶ Silicon carbide mineral
- ▶ T3: Structured abrasive type sanding disc for a more consistent cut and longer lifetime
- ▶ T4: Coated Abrasive type sanding disc for an excellent but aggressive cut

BENEFITS

- ▶ Fast removal of nibs without wild scratches
- ▶ Superior and even finish

INFORMATION

Size	Grit	P/N	Quality	Qty/Box*
32 mm	A3	22672	T3	500 per roll
	A5	22670		
	A7	22671		
	A9	22669		100 per tube
	A3	22772		
	A5	22770		
75 mm	A5	22768		200 per roll
32 mm	P1500	71360	T4	500 per tube
	P2000	71361		
	P3000	71362		

INFO : A9 = P1500 - A7 = P2500 - A5 = P3000 - A3 = P4000

*Sold only per Pack



POLISHING PADS & FOAMS

Dynabrade offers a variation of high-quality polishing products for the Automotive After Market professional. With our polishing product range, Dynabrade offers the best solution for the most critical and most time-consuming part of the repair process.

Using the right combination of our product range will lead to a serious cost reduction by decreasing labor time and achieving a faster end-result of the polishing job.

The Polishing Pads are mainly used for the more aggressive rotary polishing applications and makes it possible to re-fresh old, worn and weathered paint surfaces to high gloss polished Chrome and aluminum parts.

The Polishing Foams are mainly used to achieve the finishing touch by removing micro scratches while leaving a high gloss hologram free surface.

Due to the reticulated cell structure, the foams

keep the compound inside which reduce the consumption of polish compound while leaving a minimum of compound to wipe off.

The combination of the right compound with the right pad or foam allows you to achieve the best results in the shortest time and with the lowest consumption of products.

POLISHING PADS & FOAMS

TERRY CLOTH, SYNTHETIC WOOL AND SHEEP SKIN | 1 ITEM PER BOX

TERRY CLOTH

- ▶ The most aggressive polishing pad. To be used to (Mirror)polish Chrome and Aluminum parts.

SHEEPSKIN

- ▶ Less aggressive than Terry Cloth pad. To be used to refresh old, hard and weathered surfaces.

SYNTHETIC WHOOL

- ▶ Less aggressive than Sheepskin pad. To be used to polish weathered and dull painted surfaces and plastics.

MICRO FIBER

- ▶ Less aggressive than Synthetic Whool pad. To be used to remove small scratches on paints, plastics and clearcoats

INFORMATION

Diameter	Material	MOS	P/N	Product Name	Qty/Box*	
80 mm	Terry cloth	5,000 RPM	90027	Polishing Pad	1	
	Synthetic Wool		90028			
	Sheep skin		90080			
135 mm	Sheep skin	3,400 RPM	90081			
180 mm		2,500 RPM	90082			
200 mm	Synthetic Wool		90083			
80 mm	Microfiber	12,000 RPM	56150			20
135 mm		10,000 RPM	73502			5
180 mm		3,400 RPM	73602			2



Terry Cloth



Synthetic Wool



Sheep Skin



Microfiber

CYLINDRICAL RETICULATED POLISHING FOAMS

- ▶ High performance foams in different densities
- ▶ Ideal for rotary polishing applications
- ▶ Pineapple shaped to avoid that compound will splash around
- ▶ Strong & Heat resistant cell structure for long lifetime
- ▶ Oversized diameter to avoid that Backing Pad will touch surface
- ▶ 25 mm thick with Radius edge to achieve smooth surface results
- ▶ Grey=Hard, Blue=Medium, Black=Soft

P/N	Backing pad diameter (mm)	Outer foam diameter (mm)	Description	Holes	Qty/Pack	
72801	75	80	Cylindrical polishing Foam Black	0	Tube 20 pcs	
72800			Cylindrical polishing D-Foam Black			
73100			Cylindrical polishing Foam Blue	6		
73101			Cylindrical polishing Foam Grey	0		
73400			Cylindrical polishing Foam Grey	6		
72901			125	135		Cylindrical polishing Foam Black
73201	Cylindrical polishing Foam Blue					
73501	Cylindrical polishing Foam Grey					
73001	150	180	Cylindrical polishing Foam Black	0	2	
73301			Cylindrical polishing Foam Blue			
73601			Cylindrical polishing Foam Grey			



POLISHING FOAM TUBE HOLDER

HOLDS TWENTY 80 MM POLISHING FOAMS | 1 ITEM PER BOX

Material	Part Number	Size
Metal	22008	94 x 548 mm

For cylindrical Foams 80 mm only



CONICAL RETICULATED POLISHING FOAMS

- ▶ High performance foams in different densities
- ▶ Ideal for Random Orbital polishing applications
- ▶ Pineapple shaped to avoid that compound will splash around
- ▶ Center hole to reduce friction caused by eccentric movement
- ▶ Strong & Heat resistant cell structure with stiff interface layer for long lifetime
- ▶ Oversized conical diameter to avoid that Backing Pad will touch workpiece
- ▶ 20 mm thick with Radius edge to achieve smooth and hologram-free surface results
- ▶ Grey=Hard, Green=Hard/Medium, Blue=Medium/soft, Black=Soft



P/N	Backing pad diameter (mm)	Outer foam diameter (mm)	Description	Holes	Qty/Pack
74017	32	45	Conical polishing Foam Mini Blue	0	50
74018			Conical polishing Foam Mini Green		
74019			Conical polishing Foam Mini Grey		
74000	75	87	Conical polishing Foam Black		
74001			Conical polishing Foam Blue		
74002			Conical polishing Foam Grey		
74009	125	138	Conical polishing Foam Black	1	5
74010			Conical polishing Foam Blue		
74011			Conical polishing Foam Green		
74012			Conical polishing Foam Grey		
74013	150	160	Conical polishing Foam Black		2
74014			Conical polishing Foam Blue		
74015			Conical polishing Foam Green		
74016			Conical polishing Foam Grey		

MICROFIBER WIPES

IDEAL FOR DYNABRADE'S "TWO-STEP" SYSTEM

APPLICATIONS

- ▶ Fast and complete removal of polish and paste residual after buffing/polishing.

FEATURES AND BENEFITS

- ▶ Silicone free. Excellent absorbency and quick drying.
- ▶ No edges (art. 22050) – totally scratch-free because there is no sewing tread (art. 22000: sewn edges)
- ▶ Transparent printing – special print is scratch-free with no damage to sensitive surfaces

INFORMATION

Container	Size	Part Number	Qty/Box
Blue & Yellow*	40 x 40 cm	22000	20
Orange	40 x 40 cm	22050	20

* Package includes 10x Blue & 10x Yellow colors can not be ordered individually



FOR COMPLETE RANGE OF ABRASIVE SYSTEM PRODUCTS



Download our complete abrasive catalogue here

TIPS AND TECHNIQUES FOR POLISHING WITH DYNABRADE COMPOUNDS AND PADS / FOAMS

HOW AND WHEN SHOULD THE POLISHING PADS BE CLEANED?

- ▶ If the pad begins to dust or stick during polishing, it is time to clean and remove the accumulated dirt and used polish from it. After polishing, all pads can be washed with water and a little cleaning agent. Note that lambskin pads should be left wet and re-attached to the hook face of polishing plate in order to prevent them from shrinking and losing their shape.

THE POLISH OFTEN SPLATTERS WHEN I USE THE POLISHER. WHAT AM I DOING WRONG?

- ▶ This can be caused by various reasons:
 - a) The polisher is turned on before bringing the pad into contact with the paint (frequent beginner's error)
 - b) Polisher speed too high
 - c) Too much polish
 - d) Tilting of polisher / formation of dust when polishing edges
 - e) Use of new pad that has not yet been worn in
 - f) Fresh pad, into which the polishing compound has not been distributed evenly prior to polishing

CONSIDERATIONS WHEN USING A NEW POLISHING PAD

1. Make sure that the entire surface of each new pad is coated sparingly and evenly with the required polish. (Note: Any part of the pad that is not coated with polish may cause micro-scratches.)
2. The rubbing compound should be spread across several points onto the paint surface with the pad and then distributed evenly and rubbed in (BEFORE TURNING ON THE POLISHER). The aim is to have sufficient unused rubbing compound over the entire surface in order to ensure a uniform cut.
3. Now set the polisher/pad onto the paint surface and check whether you have set the polisher to the right speed.
4. Always START the polisher ON the surface and STOP the polisher OFF the surface.
5. The actual polishing process can now begin. Switch on the polisher.

IMPORTANT: you do not need to exert heavy downward force to keep the Backing Pad and abrasive flat on the surface.

6. Make sure that the area of the surface you wish to work on is not too large. Always remember: you should be able to cover the selected surface from one comfortable position. Do not reach or extend beyond a comfortable range. You want to be able to keep uniform pressure across the entire area being polished. A 50 x 50 cm area is a common size to work at one time
7. Follow a set pattern when buffing. It is suggested to pass over the surface, following a criss-cross "North, South, East, West" pattern, overlapping each pass by 50% of the diameter of the pad. (see diagram below) This ensures that a uniform finish is achieved. (See Figure A)

Check your progress and completely clean the surface with new microfiber towel. Wipe in a straight motion (not circular) to be able to detect any areas that might need additional work. If any defects are noticed, reapply compound to the pad and continue in that area until the surface is free of all defects. Always clear away and completely remove any polishing compound residues before progressing to the next area or polishing step. Do not use the same microfiber towel for different grades of compound.



22017

22021

22011



Microfiber

Terry Cloth

Synthetic Wool

Sheep Skin



Figure A

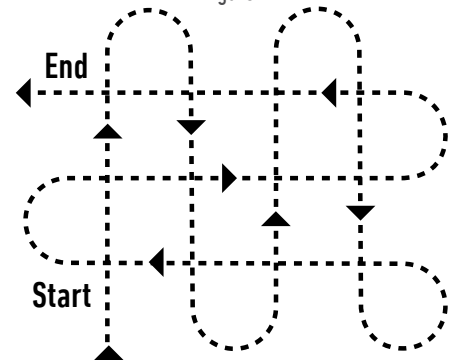

DYNABRADE WARRANTY INFORMATION

Dynabrade Pneumatic "Teal" Tools Lifetime Warranty

**LIFETIME
WARRANTY**

All tools must be registered at www.Dynabrade.com to qualify for Lifetime Warranty. Tools purchased beginning August 18, 2008 may be registered for Lifetime Warranty. Lifetime Warranty applies only to portable pneumatic tools manufactured by Dynabrade, Inc. in the USA. Warranty applies only to the original tool owner; warranty is non-transferable.

All Dynabrade portable pneumatic power tools are rigorously inspected and performance tested in our factory before shipping to our customers.

Dynabrade warrants all Dynabrade portable pneumatic power tools against defects of workmanship and materials under normal use and service for the lifetime of the tool as set forth herein.

Upon examination and review at Dynabrade's factory, Dynabrade shall confirm whether the tool qualifies for warranty status, in which case Dynabrade will repair or replace the tool at no charge to the customer.

This warranty is contingent upon proper use of the tool in accordance with factory recommendations, instructions and safety practices. It shall not apply to equipment that has been subjected to misuse, negligence, accident or tampering in any way so as to affect its normal performance.

This warranty does NOT cover normally wearable parts and accessories, including, but not limited to, bearings, contact wheels, rotor blades, regulators, valve stems, levers, shrouds, guards, O-rings, seals, gaskets and other wearable parts. Dynabrade only warrants such normally wearable parts and accessories against manufacturing defects at the time of receipt. If, upon receipt and prior to use, a normally wearable part or accessory is found to be defective, Dynabrade will repair or replace such part or accessory at no charge to the customer.

To activate Lifetime Warranty, customer must register each portable pneumatic power tool at www.dynabrade.com. Dynabrade will not honor Lifetime Warranty on unregistered tools. A one-year warranty will be honored on all unregistered portable pneumatic power tools. (In European countries, warranty on unregistered tools will be two years.) Customer must return the defective unregistered tool to Dynabrade within one year (or two years in European countries) from the date of purchase.

To be considered for warranty, tools must be sent back to our factory, transportation prepaid by user. Please send tool back to attention "Repair Department" with note fully explaining the nature of the problem along with a copy of original invoice indicating model and serial number.

THIS WARRANTY IS MADE IN LIEU OF ALL OTHER WARRANTIES, EXPRESS OR IMPLIED, INCLUDING, BUT NOT LIMITED TO, WARRANTIES OF MERCHANTABILITY OR FITNESS FOR A PARTICULAR PURPOSE, AND THERE ARE NO OTHER WARRANTIES THAT EXTEND BEYOND THIS EXPRESS WARRANTY.

Dynabrade will not be liable for damages to products, other property or persons due to improper use or through attempts to use products for other than their intended use. DYNABRADE WILL NOT BE LIABLE TO CUSTOMER OR ANY THIRD PARTY FOR ANY SPECIAL, CONTINGENT, INCIDENTAL, INDIRECT OR CONSEQUENTIAL DAMAGES. Dynabrade's liability with respect to a claim for any other damages arising out of or connected with the manufacture, sale, purchase, non-delivery, use or performance of any product sold by Dynabrade will in no event exceed to the price paid for the product.

Dynabrade Nitro Series™ Tools Two-Years Warranty

**2 YEAR
WARRANTY**

Dynabrade warrants all "Dynabrade Nitro Series™" tools against defects in workmanship and materials under normal use and service for a period of 2 Years from the date of purchase as set forth herein. Customer must return the defective tool to Dynabrade within 2 Years from the date of purchase. Upon examination and review at Dynabrade's factory, Dynabrade shall confirm whether the tool qualifies for warranty status, in which case Dynabrade shall repair or replace the tool at no charge to the customer. This warranty is contingent upon proper use of the "Dynabrade Nitro Series™" tool in accordance with factory recommendations, instructions and safety practices. It shall not apply to equipment that has been subjected to misuse, negligence, accident or tampering in any way so as to affect its normal performance. This warranty does NOT apply in the following cases: (i) consumables such as Backing Pads, etc.; (ii) lack of lubrication or evidence of rust, dirt or corrosion; (iii) tools requiring normal tuneup or cleaning; (iv) tools being used after they are badly worn such as using ratchet with worn yoke; (v) ratchet anvils damaged by excessive hand torquing; (vi) use in production-type applications. This warranty does NOT cover normally wearable parts and accessories, including, but not limited to, bearings, contact wheels, rotor blades, regulators, valve stems, levers, shrouds, guards, O-rings, seals, gaskets and other wearable parts. Dynabrade only warrants such normally wearable parts and accessories against manufacturing defects at the time of receipt. If, upon receipt and prior to use, a normally wearable part or accessory is found to be defective, Dynabrade will repair or replace such part or accessory at no charge to the customer. To be considered for warranty, tools must be sent back to our factory, transportation prepaid by user. Please send tool back to attention "Repair Department" with note fully explaining the nature of the problem along with a copy of original invoice indicating model and serial number. **THIS WARRANTY IS MADE IN LIEU OF ALL OTHER WARRANTIES, EXPRESS OR IMPLIED, INCLUDING, BUT NOT LIMITED TO, WARRANTIES OF MERCHANTABILITY OR FITNESS FOR A PARTICULAR PURPOSE, AND THERE ARE NO OTHER WARRANTIES THAT EXTEND BEYOND THIS EXPRESS WARRANTY.** Dynabrade will not be liable for damages to products, other property or persons due to improper use or through attempts to use products for other than their intended use. DYNABRADE WILL NOT BE LIABLE TO CUSTOMER OR ANY THIRD PARTY FOR ANY SPECIAL, CONTINGENT, INCIDENTAL, INDIRECT OR CONSEQUENTIAL DAMAGES. Dynabrade's liability with respect to a claim for any other damages arising out of or connected with the manufacture, sale, purchase, non-delivery, use or performance of any product sold by Dynabrade will in no event exceed to the price paid for the product.

Dynabrade Portable Vacuums Two-Year Warranty

**2 YEAR
WARRANTY**

Dynabrade warrants all Portable Vacuums manufactured by Dynabrade against defects in workmanship and materials under normal use and service for a period of 2 years from the date of purchase as set forth herein.

Customer must return the defective vacuum to Dynabrade the local certified repair center within 2 years from the date of purchase. Upon examination and review at Dynabrade's repair center, it shall confirm whether the vacuum qualifies for warranty status, in which case Dynabrade's repair center shall repair or replace the vacuum at no charge to the customer.

This warranty is contingent upon proper use of the Portable Vacuum in accordance with factory recommendations, instructions and safety practices. It shall not apply to equipment that has been subjected to misuse, negligence, or accident, such as using incorrect filters. It shall also not apply to equipment that has been tampered with in any way so as to affect its normal performance.

This warranty does NOT cover normally wearable parts and products, including, but not limited to, electrical motor brushes, hoses, couplers, filters, dust bags and other wearable parts. Dynabrade only warrants such normally wearable parts and accessories against manufacturing defects at the time of receipt. If, upon receipt and prior to use, a normally wearable part or accessory is found to be defective, Dynabrade's repair center will repair or replace such part or accessory at no charge to the customer.

To be considered for warranty, vacuums must be sent back to the Dynabrade's repair center, transportation prepaid by user. Please send vacuum back to the repair center with note fully explaining the nature of the problem along with a copy of original invoice indicating model and serial number.

THIS WARRANTY IS MADE IN LIEU OF ALL OTHER WARRANTIES, EXPRESS OR IMPLIED, INCLUDING, BUT NOT LIMITED TO, WARRANTIES OF MERCHANTABILITY OR FITNESS FOR A PARTICULAR PURPOSE, AND THERE ARE NO OTHER WARRANTIES THAT EXTEND BEYOND THIS EXPRESS WARRANTY.

Dynabrade will not be liable for damages to products, other property or persons due to improper use or through attempts to use products for other than their intended use. DYNABRADE WILL NOT BE LIABLE TO CUSTOMER OR ANY THIRD PARTY FOR ANY SPECIAL, CONTINGENT, INCIDENTAL, INDIRECT OR CONSEQUENTIAL DAMAGES. Dynabrade's liability with respect to a claim for any other damages arising out of or connected with the manufacture, sale, purchase, non-delivery, use or performance of any product sold by Dynabrade will in no event exceed to the price paid for the product.

RECOMMENDED AIR SYSTEM

PNEUMATIC POWER TOOLS HAVE SEVERAL ADVANTAGES OVER ELECTRIC POWER TOOLS

One of the major advantages is durability, however, to make full use of that advantage some important steps must be followed.

A SUFFICIENT SUPPLY OF COMPRESSED AIR IS NECESSARY

The air system must be able to deliver an adequate volume of air and maintain the rated operating pressure at the inlet of the tool.

THE SUPPLY OF AIR MUST BE FREE OF CONTAMINATION

The types of contamination that need to be eliminated are water (condensation produced by the temperature change while compressing the air), rust scale (rust particles produced inside iron pipes), and atmospheric dust, (dust that is pulled into the compressor from the work environment). Also, it is important to keep dust and debris from entering the air motor when the tool is disconnected from the air supply hose. Always keep the tool air inlet, hose ends, plugs and couplers clear of dust.

LUBRICATION (OIL) THROUGH THE AIR SUPPLY IS IMPORTANT

Supplying oil to rotary vane air motors reduces friction and wear of the moving parts and provides protection for steel components.

FILTER-REGULATOR-LUBRICATOR IS RECOMMENDED

Dynabrade recommends the use of a Filter-Regulator-Lubricator at each tool station. We also encourage the use of correctly sized accessories that will deliver a sufficient supply of air. Some examples of Dynabrade air tool accessories are Dynaswivel® airline connectors, quick disconnect fittings, and in-line blow guns. All of these accessories make for suitable additions to any compressed air system.

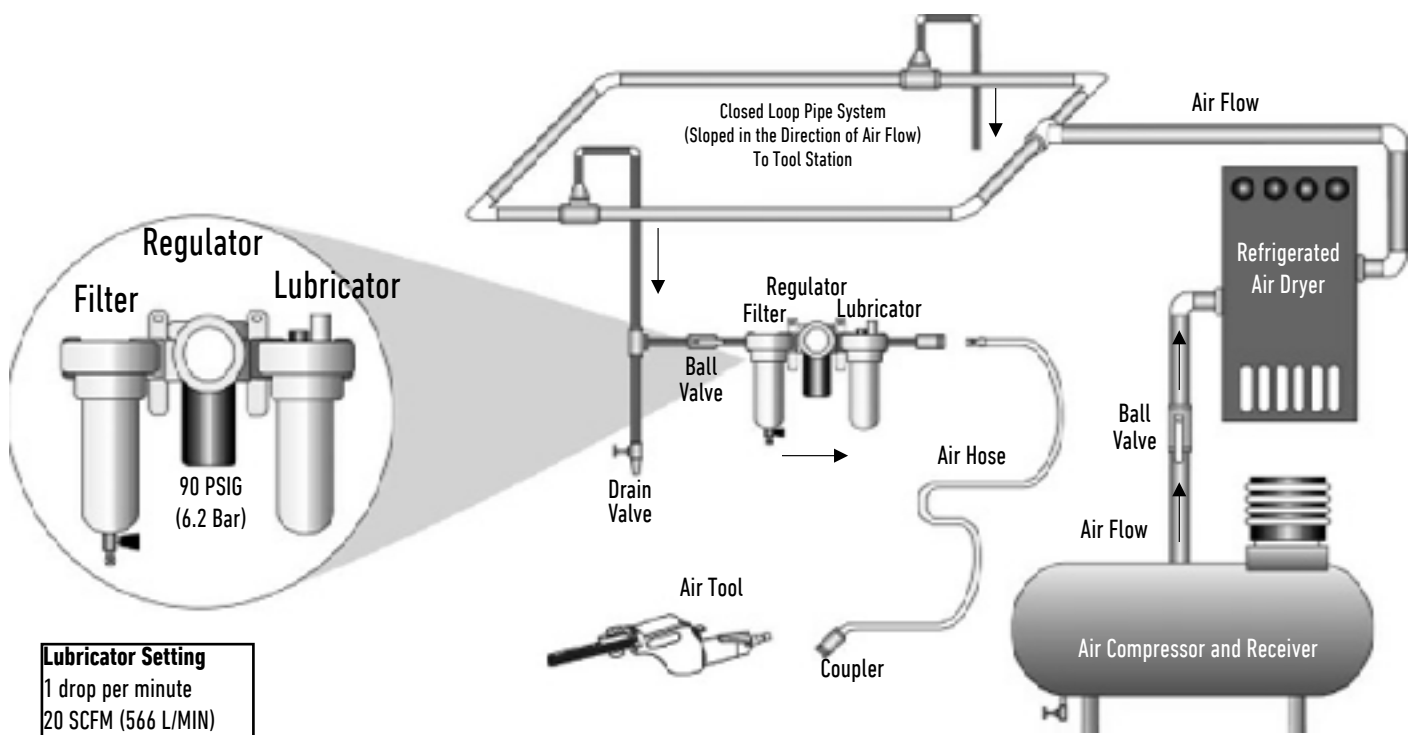

SELECTING A COMPRESSOR

GUIDELINES FOR MATCHING PROPER COMPRESSOR TO WORKPLACE

A) Compressor Type Base on your PSIG (Bar) needs

0 to 80 PSIG (5.5 bar)– You may only need a single stage compressor.

80 to 250 PSIG (17.2 bar)– You will need a two-stage compressor.

Two-stage compressors are recommended when tool use is continuous.

Note: Dynabrade air tools require operating air pressure of 90 PSIG (6.2 bar).

B) Air Consumption

Determine the total demand SCFM (l/min). List the requirements for all equipment, tools and other air consumption variables (both continuous and intermittent air usage demands).

C) Compressor Horsepower (hp)

Use the determined total demand SCFM (l/min) and add approximately 20% for system variables.

Add _____% for (your) future growth.

If the above total equals less than 100 SCFM(2,832 l/min) divide this total by 4 to find the compressor hp.

If the total is over 100 SCFM(2,832 l/min) divide by 5 to find the compressor hp.

Example: System requirements = 165 SCFM (4,673 l/min) @ 100 PSIG (6.9 bar).

$165 \div 5 = 33$ hp

Resulting in a suggested compressor size: 30 hp to 40 hp compressor

D) Tank Size

As a general rule, the larger the tank, the better the system. Use a larger tank for installations where large flows of short duration are needed.

Example: For a 5 hp compressor use a 60 Gal. (227 l), 80 Gal. (303 l) or 120 Gal. (454 l) storage tank.

E) Controls

Stop-Start: The motor stops when the compressor unloads and starts again when the pressure in the receiver drops. Use a stop-start pressure switch control for a small system. (Compressors up to 15 hp.)

Continuous Run – Equipped with constant pressure control, loading and unloading as the supply of compressed air in the receiver drops or reaches a maximum.

MAINTAINING ADEQUATE AIR FLOW

PREVENT AND ELIMINATE AIR SUPPLY RESTRICTIONS

A) Common Causes of Restriction

- The air supply hose is too long
- The inside diameter (I.D.) of the hose is too small.
- The air connections or fittings have inside diameters that are too small.
- There are too many air connections or fittings being used.
- If an inline filter is being used, the unit may be too small or the filter element may be plugged.
- If an inline regulator is being used, the unit may be too small, not adjusted properly or defective.
- The air supply hose, air fitting, air tool inlet or air tool exhaust may be plugged.
- If the air tool has a speed regulator, it may be closed.

B) Air Hose Supply

- Use the air supply hose with the correct inside diameter as is recommended by the air tool manufacturer.
- Use the shortest air supply hose possible for the task being performed.
- Longer air supply hoses require larger inside diameters.
- Coiled air supply hoses appear much shorter than they actually are. When using a coiled hose, make sure that the inside diameter is large enough to compensate for the length (see chart below).

C) Air Supply Hose Recommended Chart

Choose the correct Inside Diameter (I.D.) and Length of Air Supply Hose.

NOTE: To increase the length of air supply hose it will be necessary to increase the inside diameter of the hose.

Air Motor SCFM (Standard Cubic Feet Per Minute)	Hose & Fitting I.D Required	Recommended Length Air Supply Hose
22 SCFM (623 U/min)	1/4" (6 mm)	1' - 8' (0.3048 m - 2.44 m)
28 SCFM (793 U/min)	3/8" (10 mm)	1' - 25' (0.3048 m - 7.6 m)
35 SCFM (991 U/min)	3/8" (10 mm)	1' - 20' (0.3048 m - 6.10 m)
45 SCFM (1,274 U/min)	3/8" (10 mm)	1' - 10' (0.3048 m - 3.042 m)
73 SCFM (2,067 U/min)	1/2" (12 mm)	1' - 20' (0.3048 m - 6.10 m)

D) Air Supply Hoses (Available from Dynabrade)

- 3/8" I.D. with two male 1/4" NPT fittings. Part No. 11292 - 8 feet (2.44 m) long
- 1/2" I.D. with one male and one female 1/2" NPT fitting. Part No. 95870 - 5 feet (1.53 m) long
- 8 mm I.D. and 10 mm I.D. lightweight hoses

TIPS & TECHNIQUES

FOR MAXIMIZING PERFORMANCE SAFETY

- 1 Apply light pressure and let the burr do the work.
- 2 Keep the carbide burr moving along the surface to avoid gouging and digging causing a rough surface.
- 3 Try to end on an up stroke to generate smoother finishes.
- 4 Ensure burr is inserted into the collet and clamped down tightly.
- 5 Work on the highest material first and use light pressure while keeping the burr moving.
- 6 Make sure the work piece or surface is secure.
- 7 Avoid jamming burr into the work piece.

OPTIMIZING PERFORMANCE

MATERIALS	RECOMMENDED OPERATING SPEEDS									
Exotic Alloys	1,400-1,800 SFPM 420-540 m/min									
Hardened Steels 45HRc+	1,600-2,200 SFPM 480-660 m/min									
Non-Hardened Steels 45HRc-	2,000-2,600 SFPM 600-780 m/min									
Non-Ferrous Light Metals	2,600-3,000 SFPM 780-900 m/min									
Plastics, Hard Rubber, Fiberglass and Composites	2,400-3,000 SFPM 720-900 m/min									
BURR DIAMETER	RPM									
3-1/2" (2.5 mm)	45,000	53,000	60,000	66,000	73,000	79,000	86,000	92,500	100,000	
1/8" (3 mm)	45,000	53,000	60,000	66,000	73,000	79,000	86,000	92,500	100,000	
1/4" (6 mm)	26,000	30,000	34,000	37,500	41,500	45,000	49,000	52,500	55,000	
3/8" (9 mm)	17,500	20,000	22,500	25,000	27,500	30,000	32,500	35,000	37,500	

DIE GRINDER COLLETS & INSERTS

TERMINOLOGY

- COLLET: Device used to hold carbide burrs, rotary files, mounted points and wheels, etc.
- BODY: The part of the collet that secures to the spindle of the tool and accepts the inserts.
- CAP: Secures collet body and retains insert.
- INSERT: The collapsible portion of the collet that retains the shank of the inserted tool.

COLLET ASSEMBLY TYPES

- TWO-PIECE: Insert threads into body.
- THREE-PIECE: Insert slips into body; cap threads to body, retaining the insert.
- FOUR-PIECE: Insert slips into body; cap slips over body; nut retains cap and insert.
- INTEGRATED: Collet body is integrated into tool.



CONVERSION TABLE

LENGTH

	Meters	Centimeters	Millimeters
1 Inch (in.)	0.0254 m	2.54 cm	25.4 mm
1 Foot (ft.)	0.3048 m	30.48 cm	304.8 mm

WEIGHT

	Kilograms	Grams
1 Ounce (oz.)	0.02835 kg	28.35 g
1 Pound (lb.)	0.454 kg	454 g

POWER

	Kilowatts	Watts
1 hp	0.745 kW	745 W

VOLUME

	Liters
1 US Gallon	3.785 l

TORQUE

	Newton Meters
1 Inch-ounce	0.00706 Nm
1 Inch-pound	0.11298 Nm

COMMON SIZES

Centimeters	Millimeters
3/32"	2.5 mm
1/8"	3 mm
3/16"	5 mm
1/4"	6 mm
3/8"	10 mm
1/2"	13 mm
3/4"	19 mm
1"	25 mm
1-1/4"	32 mm
2"	50 mm
2-3/4"	70 mm
3"	75 mm
3-1/2"	90 mm
4"	100 mm

Centimeters	Millimeters
4-1/2"	115 mm
5"	125 mm
6"	150 mm
7"	180 mm
8"	200 mm
9"	230 mm
11"	280 mm
12"	305 mm
18"	457 mm
20-1/2"	521 mm
24"	610 mm
30"	762 mm
34"	864 mm
44"	1118 mm

COMMON RECTANGULAR SIZES (W X L)

Inch	Millimeter
4" x 4-5/16"	100 mm x 110 mm
4-1/4" x 4-1/12"	110 mm x 115 mm
2-3/4" x 8"	70 mm x 200 mm
2-3/4" x 11"	70 mm x 280 mm
3-2/3" x 7"	93 mm x 180 mm
2-7/8" x 3-1/8"	73 mm x 80 mm
2-3/8" x 3-3/4"	60 mm x 95 mm

Dynabrade reserves the right to update this catalogue without notice, updated versions available on www.dynabrade.com

WE LISTEN. WE OBSERVE. WE OPTIMIZE.



Dynabrade Europe S.à r.l
Zone Artisanale Op Tomm, 6
L-5485 Wormeldange-Haut, Luxembourg
Tel: +352 768 494 1 / Fax: +352 768 495

Email: customer.service@dynabrade.lu
www.dynabrade.com

Distributed By:

Automotive Aftermarket – Dynabrade Product Line **EUR21-12**